

SHIKA EXPRESS - CHEMISTRY

Version 2.0 TZ

HANDS-ON ACTIVITIES COMPANION GUIDE
TANZANIA

TEACHER'S GUIDE

May 6, 2018

Questions or Comments?

Thank you for using the *Shika Express - Chemistry* manual! If you have any questions, comments, or would like to request a copy of this manual, please use the contact information given below.

Shika na Mikono Primary Contact (shika.mikono.tz@gmail.com)

You may also contact any of the current members of the Shika na Mikono team directly using the following contact information.

Ed. 2017

Kyle Golden (kylegldn@gmail.com)
Kayla Huffman (kaylarhuffman@gmail.com)
Iain Laufer (iainlaufer360@gmail.com)
Mara McKown (marasmckown@gmail.com)
Brandi Rajala (brajala@mtu.edu)
Emily Slater (eslater6@gatech.edu)

Ed. 2016

Kalvin Croto (kmcroto@gmail.com)
Marguerite Daw (margueritedaw@gmail.com)
Katharine Kobylt (kat.kobylt@gmail.com)
Jonathan McClure (jonathanmcclure37@gmail.com)
Cailin McLaughlin (cailin_mac@yahoo.com)
Paige Van de Vuurst (paigevandevurrst29@gmail.com)

To download a digital version of this manual, please visit the [digital download page](http://pctanzania.org/shika) at the following address: <http://pctanzania.org/shika>

Feedback and requests for revisions to the content of any of the manuals can be made using the primary contact information above, or by visiting the [Shikamikonotz Project Page](https://github.com/shikamikonotz/) at GitHub: <https://github.com/shikamikonotz/>

Contents

I	Laboratory Development	5
1	Starting School Laboratories	6
2	Specific Technical Needs of a School Chemistry Laboratory	7
3	Improving an Existing School Laboratory	8
4	Salvaging Old Equipment - Repairing Burettes	10
5	Identifying Unknown Chemicals	12
II	Laboratory Safety	20
6	Guidelines for Laboratory Safety	21
7	First Aid	25
8	Dangerous Chemicals	27
9	Dangerous Techniques	33
III	Laboratory Management	34
10	Classroom Management in the Laboratory	35
11	Routine Cleanup and Upkeep	37
12	Waste Disposal	38
13	Recycling Materials	40
IV	Laboratory Techniques in Chemistry	42
14	Use of the Beam Balance for Measuring Chemicals	43
15	Use of a Plastic Syringe to Measure Volume	45
16	Measures of Concentration	47
17	Calculating the Molarity of Bottled Liquids	49
18	Preparation of Solutions	50
19	Preparation of Solutions Without a Balance	52
20	Relative Standardization	53
21	Chemistry Practicals	55
V	Hands-On Activities	62
22	Chemistry Activities for Form I	63
22.1	Introduction to Chemistry	63
22.2	Laboratory Techniques and Safety	65

22.3 Heat Sources and Flames	66
22.4 The Scientific Procedure	67
22.5 Matter	69
22.6 Air, Combustion, Rusting and Fire Fighting	77
23 Chemistry Activities for Form II	81
23.1 Oxygen	81
23.2 Hydrogen	82
23.3 Water	83
23.4 Fuels and Energy	85
23.5 Atomic Structure	87
23.6 Periodic Classification	90
23.7 Bonding, Formula and Nomenclature	92
24 Chemistry Activities for Form III	96
24.1 Chemical Equations	96
24.2 Hardness of Water	97
24.3 Acids, Bases and Salts	99
24.4 The Mole Concept and Related Calculations	103
24.5 Ionic Theory and Electrolysis	106
24.6 Chemical Kinetics, Equilibrium and Energetics	110
24.7 Extraction of Metals	112
24.8 Compounds of Metals	113
25 Chemistry Activities for Form IV	115
25.1 Non-Metals and Their Compounds	115
25.2 Organic Chemistry	121
25.3 Soil Chemistry	126
25.4 Pollution	128
Materials and Equipment	130
26 Local Materials List	131
27 Low Tech Microscopy	141
28 Storage of Materials	143
29 Pastes and Modeling Materials	144
30 Sources of Chemicals	146
Appendix	160
A Common Chemistry Root Words	160
B Activity Template	162

Part I

Laboratory Development

Starting School Laboratories

A science laboratory is any place where students learn science with their hands. It might be a room, or just a box. The goal is to develop a space that facilitates hands-on learning.

1.1 Benefits of a School Laboratory

There are many benefits of having a laboratory:

- Students learn more and better science
- Students get more excited about science class
- Students have to go to the lab for class, thus eliminating those too lazy to walk over
- Practical exams are easier than the alternative-to-practical exams
- Everyone thinks practicals are important, and that science without practicals is silly.

1.2 Challenges of a School Laboratory

There are some challenges with having a laboratory:

- They are places where people can get hurt
This is true. Please see the sections on [Classroom Management in the Laboratory](#) (p. 35) and [Laboratory Safety](#) (p. 21) to mitigate this risk.
- Many teachers do not know how to use a laboratory
Then use the lab to teach them how to use it, thus spreading skills.
- Laboratories are far too expensive for poor schools to build and stock
This is simply incorrect. Any room will work for a lab, and any school can afford the materials required to stock it. The rest of this book is dedicated to this point.

So you want to build a laboratory?

1.3 Step one: Location

A permanent location is obviously preferable. If your school has an extra classroom, great. The only requirements of a potential room are that it be well ventilated (have windows that either open or lack glass altogether) and be secure: bars in the windows, a sturdy door, and a lock. If you plan to put fancy equipment in your lab, remember that hack saw blades are cheap and that the latch through which many pad locks pass can be cut quickly regardless of the lock it holds. But if you are just starting, there will probably not be any fancy equipment; a simple lock is enough to keep overly excited students from conducting unsupervised experiments.

If there is no extra space at all, the lab can live in a few buckets and be deployed in a classroom during class time. “There is no lab room,” is no excuse for not having a lab.

1.4 Step two: Funding

Yes, some is required. But the amount is surprisingly little – in most countries a single month of a teacher’s salary is enough to furnish a basic laboratory. Almost every school can find the amount required to get started, and if not the community certainly can. A single cow in most countries would pay for a basic laboratory many times over. A cow is valuable. So is science education.

We encourage you to resist the temptation to ask people outside of the school community or school system to pay for the lab. There is simply no need to encourage that sort of dependence; this can be done locally, and it should be.

Specific Technical Needs of a School Chemistry Laboratory

A basic chemistry laboratory should allow for the following investigations:

- Distinguishing compounds from mixtures, preparing chemical compounds, separating mixtures
- Changes in the state of matter (melting/freezing, evaporation/condensation, sublimation/deposition, dissolution/crystallization)
- Comparison of metals and non-metals
- Comparison of covalent and ionic (electrovalent) compounds
- Observing various elements and compounds and their reactivity with air, water, acids and bases
- Acid/base, oxidation/reduction, and precipitation reactions
- Energy changes from chemical reactions (thermochemistry, energetics)
- Factors affecting the rates of chemical reactions (chemical kinetics)
- Properties of gases (gas laws)
- Preparation of gases (hydrogen, oxygen, carbon dioxide)
- Electrochemical experiments (conductivity, electrolysis, electroplating, voltage generation)
- Volumetric analysis (titration)
- Identification of unknown salts (“qualitative analysis”)
- Very basic organic reactions (e.g. preparation of ethanol by fermentation, oxidation of ethanol to ethanal)

Key materials are:

- Containers, bottles, tubes, balloons
- Tools for measuring volume (calibrated plastic water bottles, plastic syringes)
- Low cost balance (digital)
- Heat sources and open non-luminous flames
- Stopwatches
- Power supplies (e.g. batteries) and wires
- Wide variety of chemicals including metallic elements, non-metallic elements, solid covalent compounds, salts, acids, bases, redox reagents, indicators, and many chemicals for specific kinds of reactions

Improving an Existing School Laboratory

If there is already a laboratory at your school, the immediate tasks are to see what it has, make it safe, get it organized, make repairs, and ensure smart use with sound management.

3.1 Inventory

- Making a list of what and how much of everything is in your lab is easy, if time consuming. Difficulties arise when you find apparatus you have never seen before, or containers of chemicals without labels.
- Unknown apparatus are not harmful nor useful until you know what they do. Ask around.
- Unknown chemicals, however, pose a hazard, because it is unclear how to properly store them or how to clean up spills. If a chemical is unknown, there is no safe way to responsibly dispose of it. Therefore, it is best to attempt to identify unknown chemicals. For assistance in identifying unknown chemicals, please see [Identifying Unknown Chemicals](#) (p. 12).
- Burettes should be tested to ensure that they work. See [Salvaging Old Equipment - Repairing Burettes](#) if burettes need to be repaired.

3.2 Organize

Have enough space

The key to organization is having enough space. Usually, this means building shelves. In the long term, find a carpenter to build good shelves. In the short term, boards and bricks, scrap materials, chairs, anything to provide sturdy and horizontal storage space. It should be possible to read the label of every chemical, and to see each piece of equipment.

Apparatus

- Arrange apparatus neatly so it is easy to find each piece.
- Put similar things together.
- Beakers can be nested like Russian dolls.

Chemicals

- Organize chemicals alphabetically. There are more complicated schemes involving the function or the properties of the chemical but what is most important is a scheme that everyone working in the lab can follow. ABC is the easiest, and has the best chance of being used. A good alternative is to organize by chemical makeup (e.g. sodium, etc.)
- Glass bottles of liquid chemicals should be kept on the floor, unless the laboratory is prone to flooding, in which case they should be on a sufficiently elevated, broad and stable surface. What you do not want are these bottles falling and breaking open.
- Million's Reagent, benzene, and other chemicals that should never be used should be kept in a special place, ideally locked away, and labelled to prevent use. See [Dangerous Chemicals](#) (p. 27) for a list of chemicals that should never be used.
- Label plastic containers directly with a permanent pen, especially if the printed label is starting to come off.
- Replace broken or cracked containers with new ones.

Make a map and ledger

- Once you have labeled and organized everything in a lab, draw a map.
- Sketch the layout of your laboratory and label the benches and shelves.
- In a ledger or notebook, write down what you have and the quantity. For example, Bench 6 contains 20 test tubes, 3 test tube holders, and 4 aluminum pots.

This way, when you need something specific, you can find it easily. Further, this helps other teachers – especially new ones – better use the lab. Finally, having a continuously updated inventory will let you know what materials need to be replaced or are in short supply. Proper inventories are a critical part of maintaining a laboratory, and they really simplify things around exam time.

3.3 Repair/Improve

Once the lab is organized, it is easy to find small improvements. Here are some ideas:

Build more shelves

You really cannot have too many.

Fix broken burettes

Burettes are useful, expensive and – if glass – fragile. Broken burettes can often be made functional again. If you have broken burettes, see [Salvaging Old Equipment - Repairing Burettes](#) (p. 10).

Identify key apparatus needs

Sometimes a few pieces of apparatus can be very enabling, like enough measuring cylinders, for example. Buy plastic!

3.4 What next?

Once the lab is safe and organized, develop a system for keeping it that way. Consider the advice in [Routine Cleanup and Upkeep](#) (p. 37). Make sure students and other teachers in involved.

Then, start using the lab! Every class can be a lab class. That is the whole point.

Salvaging Old Equipment - Repairing Burettes

First, if you need burettes, consider buying plastic burettes. They are widely available if you ask persistently and they tend not to break. This may be hard as many suppliers prefer to sell glass burettes. Why? As one supplier told us, "Because when people buy plastic burettes, they don't return." The good news for every school with glass burettes is that often broken burettes can be repaired.

The top of the burette is broken, above the 0 mL line.

This burette is still fully functional. A student will probably need a beaker for filling the burette, but she should be using one anyway. Use a metal file (best!), stone, or piece of cement to gently grind the broken edge smooth to prevent cuts.

The burette is broken in the graduated section, that is, between 0 - 50 mL.

This burette is still slightly useful for titrations if it has most of its length. Students will just have an initial volume of 7 ml, perhaps. If it has broken around the 45 ml mark, no such luck. The burette tube however, is still quite useful as a glass pipe. Keep it around for other kinds of experiments. At the very least you have a glass rod for mixing solutions. Regardless, grind the edges smooth as in case one.

The burette is broken below the 50 ml but above the valve.

To fix this, you need a Biafa (fake Bic) pen and about 8cm of rubber tubing. Orange gas supply tubing is best, but hard to find. The black rubber of the inside of bicycle pump hoses also works.

- First, cut off the tip of the pen, the first 2 cm of so, and attach the non-tapered end of it to the tubing. Cutting is easiest done by scoring all the way around with a razor blade and then cleanly snapping the shaft. Remove any plastic burrs from the cut edge and then insert the wider end of the severed tip into the plastic tubing so the narrow end hangs out.
- Second, remove from the pen the little plastic end cap (the one that tells you what color ink you have) and insert it into the tubing, curved side first. Push it about half way down the tube using your fingers like esophageal peristalsis and make sure that the axis of symmetry of the pen cap stays aligned with that of the rubber tubing. That is, if the now discarded pen were still there, it would be surrounded by the tube.
- Finally, attach the other end of the tubing to the broken burette. Again, grind the sharp glass end to smooth it. What you should end up with is a burette that does not pass solution except when you press on the tubing around the pen end cap, deforming the tube to allow liquid to pass. With practice this can be easier than using a valve, and just as accurate.

Steel ball bearings are available for cheap at bicycle supply shops. These might be an alternative to the end caps of Biafa pens if you can get them in the right size. Experiment!

The valve is jammed

No problem! Soak it in dilute acid (not nitric) until it is free.

The valve is hopelessly broken.

Break the burette just above the valve and follow the instructions above. Soak a string in something flammable – kerosene, nail polish remover – and gently squeeze out the excess. Tie the string around the shaft where you want to "cut" the glass and remove the excess string. Dry up any liquid that spilled on other parts of the glass. Light the string on fire and rotate to make sure it burns evenly. After five or so seconds of burning, plunge the piece into a beaker or bucket of water. The contraction of the rapidly cooling glass should break the burette along where you tied the string. Grind the edge to smooth it.

The burette is broken below the valve.

This problem is mostly aesthetic, but to fix it you only need about 3 cm of rubber tubing and a clear plastic pen. Cut the tip from the pen as above and insert it into the tubing. Then stick the other end of the tubing onto the broken burette, grinding down the glass edge before you do.

The rubber tubing is cracking.

This usually comes from leaving clamps on the tubing during storage. To fix this, replace the rubber tubing. But while you are at it, insert a pen cap as in case three and do away with the clamps. They are more difficult to use and not as sensitive.

Identifying Unknown Chemicals

Unlabelled chemicals are dangerous. If you do not know what the chemical is, then you do not know what to do if it spills, or how to safely get it out of your school.

5.1 Identifying Bottles of Unknown Liquids

Usually, these are:

- Concentrated acids (sulfuric, hydrochloric, nitric, ethanoic)
- Concentrated ammonia solution
- Organic solvents including methanol, ethanol, isobutanol, propanone (acetone), diethyl ether, ethyl ethanoate (ethyl acetate), dichloromethane, trichloromethane (chloroform), tetrachloromethane (carbon tetrachloride), trichloroethene, benzene, chlorobenzene, toluene, xylene, and petroleum spirits

Distinguishing these chemicals is important, and relatively possible. Here is a procedure:

1. **Protect yourself against whatever it might be.**

Concentrated acids burn skin on contact and blind if they get in the eyes. Concentrated hydrochloric acid and concentrated ammonia solution release fumes that corrode the throat and lungs. Diethyl ether and propanone rapidly evaporate at room temperature and pose a significant flash fire hazard if opened near flame. Ingesting even a small amount of toxic carbon tetrachloride can be fatal, and benzene is a proven and serious carcinogen.

Why, you might say, should I even attempt this? Because sooner or later, someone will, and better it be someone with these instructions than without. But if you do not feel comfortable, call a friend who is more excited about this process.

Many precautions are available.

- Tie a cloth over your mouth and nose to mitigate inhalation.
- Find a pair of goggles or sunglasses to protect your eyes from any splash when opening the stopper in the bottle.
- Wear gloves or at least plastic bags on your hands. Neither will protect your hands for more than a second or a few against concentrated acids or some organics, but that second can be useful in this case.
- Thick rubber gloves are available and offer greater protection.
- Regardless, have at the ready a bucket of water and a box of baking soda (bicarbonate of soda) to neutralize acid burns.
- Move the container outside and remain upwind.
- Have a small, dry, clean beaker ready to hold a sample.

2. **Open the bottle.**

This may be as simple as unscrewing the top or there may be an internal stopper that requires prying off.

- Find a suitable tool, one that can pry under the cap but cut neither the cap nor you. A butter knife works well. *Do not use your fingers.*
- When the bottle opens, look at the top. Are there white fumes? Is there an obvious smell that you can perceive from where you are standing? White fumes suggest hydrochloric acid and an intense smell could be ammonia (smells like stale urine), hydrochloric or ethanoic acid (both smell like vinegar), or an organic solvent (various odors).
- If the contents smell obviously like ammonia, there is no need to further experimentation. Nothing else in schools smells even remotely like ammonia. Stopper that bottle and give it a good label.

- Otherwise, carefully, pour a few cubic centimeters of the liquid into your sample beaker. As you pour the liquid, observe the viscosity. Concentrated acids are all noticeably more viscous than water, especially concentrated sulfuric acid. Propanone, on the other hand, is noticeably more fluid than water. Close the bottle and take the beaker to a safe place for experimentation.
- Color is surprisingly useless in identifying unknown liquids because most readily take on color from even small amounts of contamination.
- Rest the beaker on a sturdy surface. If you have already noticed an intense smell, leave the cloth on your face. If you have not yet noticed a smell, remove it.

5.2 Test one: Add to water

- Fill a large, clean test tube half way with ordinary water. Alternatively, find the smallest beaker you have (probably 50 mL), and fill it about a quarter of the way with water. Carefully pour in a few drops of your unknown and observe what happens.
- If it does not mix with the water, instead forming a new (possibly quite small) layer on top, you have an *organic solvent less dense than water*, probably one of: isobutanol, diethyl ether, ethyl ethanoate, benzene, chlorobenzene, toluene, xylene, or petroleum spirits.
- If it does not mix with the water, instead sinking to form a distinct layer on the bottom, you have an *organic solvent more dense than water*, probably dichloromethane, chloroform, or carbon tetrachloride.
- If your unknown does not mix with water, jump down to [Test four: What kind of organic?](#) on what to do with organics.
- If the unknown seems to sink into the water but not mix completely, you probably have a *concentrated acid*. The test tube might even get a little warmer. You might also have a very concentrated solution of some other solute, left over from a previous experiment.
- If the unknown seems to mix into the water like, well, water, you probably have an *aqueous solution* that is not very concentrated. It might be dilute acid, dilute hydroxide, hydrogen peroxide solution, etc. – more work lies ahead.

5.3 Test two: Is it an acid?

This only applies to solutions that mix completely into water.

1. This is easy with a piece of blue litmus paper. Dip a corner down into the test tube or beaker.
 - If it turns bright red, you probably have an *acid*, and if your liquid was noticeably viscous, a concentrated acid.
 - If there is no change, move on to [Test five: What else?](#)
2. Another option is universal indicator or universal pH paper.
 - Prepare a 100-fold dilution of the original acid and test with the indicator.
 - If the color is bright red, you must have a *strong acid*, like hydrochloric, sulfuric, or nitric acid.
 - If the color is instead orange or yellow, you must have a *weak acid*, like ethanoic acid.
3. If there is no universal indicator, you can show that something definitely is an acid if it causes methyl orange to turn from orange to red. However, if there is no color change, you might still have a weak acid, so you cannot use methyl orange to eliminate the possibility of an acid.
4. You also cannot use POP to show that there is an acid, as both concentrated acid and tap water have the same effect on POP: none whatsoever.
5. If you do not have any litmus paper or other indicator, find another beaker and add 10-20 mL of ordinary water and dissolve a bit of baking soda (bicarbonate of soda). Carefully, with eye protection, add a few drops of your DILUTED unknown (from test one). If there are bubbles, you have an *acid*. Adding a concentrated acid directly to baking powder can cause such vigorous effervescence as to eject acid from the test tube.

5.4 Test three: What kind of acid?

5.4.1 Sulphuric acid

- Hints: obviously viscous, significantly denser than water, noticeable heat released on dilution, no smell
- Confirmatory test: dip the wooden end of a match into the original solution. If the end appears to char, you have concentrated sulfuric acid. Another variant of this test is take some concentrated sulfuric acid and pour over some sugar in a beaker. After some time, a black color from carbon produced from the dehydration of sugar confirms sulfuric acid. Yes, the same thing happens to skin. The downside of this second test is that the beaker is almost impossible to clean.
- Alternative test: Find or prepare a 0.1 M barium nitrate, barium chloride, or lead nitrate solution. In a test tube, add about one centimeter of your diluted sample and then a few drops of one of the above solutions. An instant, white, cloudy precipitate demonstrates that sulfate is present. To confirm that this is from sulfuric acid and not, say, your tap water, test in the same way the water you used for the dilution. Not much should happen. If your tap water contains sulfates, find some distilled (e.g. rain) water and remake the dilution.

5.4.2 Hydrochloric acid

- Hints: white fumes, intense acidic smell similar to vinegar, more dense than water
- Confirmatory test: prepare a dilute potassium permanganate solution. This should be pink in color, which might require significant dilution. Fill a test tube with a couple centimeters of your dilute solution and add the potassium permanganate solution drop wise. If the pink color is rendered colorless after mixing with your diluted sample, you probably have hydrochloric acid. This reaction makes small amounts of chlorine gas, but that poses much less risk than the hydrochloric acid fumes.
- Alternative test: Find or prepare a 0.05 M or 0.1 M silver nitrate solution. Remember that this chemical is very expensive, so only make a small quantity. In a test tube, add about one centimeter of the water you used for diluting your sample and then a few drops of one of silver nitrate solution. An instant, white to gray, cloudy precipitate demonstrates that chloride is present. If this happens, your tap water contains chlorine and you will have to prepare another dilution using rain or distilled water. If the water you used for dilution lacks chlorine, add a centimeter of the diluted sample to a clean test tube and add a few drops of silver nitrate solution. The precipitate confirms that you have hydrochloric acid. Note that for this test to be effective, the hydrochloric acid must be diluted. Concentrated hydrochloride acid reacts with aqueous silver to form the $[\text{AgCl}_2]$ -complex, which is soluble.

5.4.3 Ethanoic (acetic) acid

- Confirmatory Test: This acid smells strongly of vinegar. If you have a definite vinegar smell, it is probably ethanoic acid, but beware that concentrated HCl can have a similar smell. To confirm ethanoic acid, use some diluted acid from test one and add a small amount of baking soda until it is just neutralized. Do not add excess baking soda - neutralization is the goal. After neutralizing, add a small amount of iron (III) chloride or nitrate. A blood red solution of iron (III) acetate proves that the acid is ethanoic. Boiling the solution should form a red brown precipitate. If you do not have iron (III) salts but do have universal indicator, use the indicator method above for confirming that your unknown is a weak acid – ethanoic is the only common weak acid that smells like vinegar.

5.4.4 Nitric acid

A concentrated acid in a school that does not smell like vinegar and is not hydrochloric or sulfuric acid is very likely to be nitric acid.

- Confirmatory Tests: Take a wooden splinter or match stick and dip it in the concentrated acid. If the splinter turns yellow, the acid is nitric. A second confirmatory test is adding copper wire or

turnings to the concentrated acid. A brown gas of nitrogen dioxide is formed. Do this confirmatory test in a well ventilated area.

- Special note: if you suspect nitric acid, dip a piece of copper wire into the solution. If it comes back with a silvery coating, you have Millions Reagent, mercury metal dissolved in nitric acid. This is highly toxic, very dangerous, and should never be used in a school. Label the bottle Millions Reagent, Contains Hg_2^+ , TOXIC, CORROSIVE, do not use, do not dump along with similar warnings in any local language(s) and find a safe place to store it.

5.5 Test four: What kind of organic?

Let us be honest. Distinguishing between different kinds of organic solvents is hard with the resources that are probably available.

- If the chemical is more dense than water and no one at the school claims that it is chloroform (trichloromethane) for the biology lab, there is no way to show that it is not carbon tetrachloride (tetrachloromethane), a toxic organic solvent responsible for the death students in several countries. Label the bottle “Unknown organic solvent more dense than water, possibly carbon tetrachloride, TOXIC, never use, never dump,” with similar warnings in any local language(s) and find a safe place to store it.
- If the chemical is less dense than water and you are familiar with organic solvents, you might try a careful smell test.
- If the unknown smells like strong booze and is soluble in water, it is probably ethanol or methanol. Do not drink it! – methanol blinds.
- If it is bright red, it is probably Sudan III solution, for biology. Label and use it.
- If it is yellow or brown it might be iodine solution, see below in test five.
- If it is light purple or green or whatever the popular color in your country, it is probably methylated spirits, a mixture of about 70% ethanol and 30% water with some impurities to make it undrinkable. Confirm this by showing that paper soaked in the chemical will burn with a blue flame but that paper soaked in a 50/50 mixture of the chemical and water will not burn.
- If it is clear and someone at the school can assure that the contents are ethanol and not methanol, label the bottle “ethanol” and use it.
- If the bottle might be methanol, a poison, pour the contents into a large bucket and leave it in a place where no one will disturb it and where the fumes will not accumulate. Let it evaporate.
- If the unknown smells like nail polish remover and is soluble in water, it is probably propanone (acetone).
- If you put a drop in a spoon it should evaporate relatively quickly. Label it “Propanone, EXTREMELY FLAMMABLE” and keep it around.
- If it is not soluble in water and smells like magic markers, it is probably diethyl ether or ethyl ethanoate (ethyl acetate). If you are familiar with organics, perhaps you can pick between these. Otherwise just label the bottle “volatile organic solvent, insoluble in water, EXTREMELY FLAMMABLE” and keep it around.
- If the unknown has a sweet sickly smell it might be toluene. It also might be benzene.
- If you cannot further identify it and no one else can, label the bottle “unknown non-volatile organic solvent less dense than water, possibly benzene, TOXIC, never use, never dump” with similar warnings in any local language(s), and find a safe place to store it.

5.6 Test five: What else?

If your unknown is not an acid, not ammonia, and soluble in water, see what it smells like.

- If it smells like booze or nail polish remover, it could be methanol, ethanol, or acetone. See the above section on organics.
- If it does not have a smell, it is probably a solution left over from an earlier lab. These are not nearly as dangerous as concentrated acids or some volatile organics. However, be sure to use proper handling methods.

Here are some possibilities:

5.6.1 Sodium hydroxide solution

- Hints: cloudy and a jammed stopper, but not always
- Test: red litmus turns blue or POP pink.
- What to do: sodium hydroxide is cheap when bought as caustic soda. Keep it around just for neutralizing acid wastes. If its presence disturbs you, add some indicator and then cheap acid until neutralization. After complete neutralization, dump.

5.6.2 Hydrogen peroxide

- Hints: colorless liquid, in an opaque or dark bottle
- Test: add a bit of acidified potassium permanganate solution. The potassium permanganate should turn colorless on mixing and bubbles of gas should be observed.
- What to do: label and use. If you want to dispose of it for some reason, leave it in a bucket in the sun.

5.6.3 Potassium permanganate solution

- Hints: intensely purple, pink after significant dilution
- Test: to a very dilute solution, add crushed vitamin C (ascorbic acid) from a pharmacy. The solution should turn colorless.
- What to do: test the pH with litmus paper or methyl orange to see if acid has been added. Then label “(acidified) potassium permanganate” and use. If you want to dispose of it, add crushed vitamin C until the color disappears and then pour into a pit latrine.

5.6.4 Iodine solution

- Hints: brown color, smells like iodine tincture, and possibly also like ethanol
- Test: to a dilute solution, add crushed vitamin C (ascorbic acid) from a pharmacy. The solution should turn colorless.
- What to do: Put a centimeter of water in a test tube followed by a smaller quantity of cooking oil. Add a few drops of the solution, cap with your thumb and mix thoroughly for one minute. If two layers quickly separate, the iodine solution has been prepared without ethanol. If a cloudy mixture (an emulsion) forms, the iodine solution has been prepared with ethanol. Label the solution “iodine solution (with ethanol)” and use it.

5.6.5 Potassium ferrocyanide solution

- Hints: light neon green or yellow color
- Test: make a dilute solution of copper sulfate and add a few drops of the unknown. An instant, massive brown precipitate confirms potassium ferrocyanide solution.
- What to do: Label and use. Do not dump while it remains useful.

5.7 Unidentifiable Liquids

... are worthless. In order to safely dump a liquid chemical, ensure the following are true:

- The liquid is water soluble (otherwise see the organic section above)
- The liquid is neutral pH (if acid, neutralize with bicarbonate of soda, if base neutralize with acid waste, citric acid, or, carefully, battery acid)
- The liquid does not contain heavy metals (to a small sample, add dilute sulfuric acid drop-wise. A precipitate indicates lead or barium. Continue adding until additional precipitation stops. Then neutralize with bicarbonate of soda. The solids are safe for disposal in a pit latrine, but may clog sink pipes).
- The liquid does not contain mercury (to a small sample, add sodium hydroxide solution until POP turns the solution pink. A yellow precipitate indicates mercury. Label the solution “Contains Hg_2^+ , TOXIC, do not use, do not dump” and store it in a safe place.)

Then, dilute the chemical in a large amount of water and dispose of it in a lab sink or pit latrine.

5.8 Deliquescent Salts

If you have a chemical in a container that seems meant for holding solids but the chemical looks like a thick liquid, you probably have a deliquescent salt that fully deliquesced. These solutions can be quite dangerous because they are maximally concentrated. Make sure that no unknown chemicals touch your skin, and wear goggles for this work. Then, do the following:

5.8.1 Test for a base

The most common deliquescent salt is sodium hydroxide.

- Fill a test tube half way with water and a few drops of the unknown syrup followed by a few drops of POP indicator. If the solution turns pink, you almost certainly have either *sodium hydroxide* or *potassium hydroxide*.
- Dilute the liquid in at least 10 times its rough volume of water and titrate a sample against 1 M acid.
- Find a plastic water bottle with a screw cap for your dilution and label it “sodium or potassium hydroxide, n M”, where n is the molarity you measured in your titration.

5.8.2 Color

If the liquid is not a base, it is probably a chloride or nitrate salt of one element or another.

- If it is colorless, the cation is probably in Group IIA (Ca, Sr, or Ba) or Group IIB (Zn, etc). Group IIA compounds have distinct flame test colors:
 - Ca = orange red,
 - Sr = bright red,
 - Ba = apple green

while Zn has no flame test color.

- If it is red or brown, it is probably iron (III) nitrate or iron (III) chloride.
- If it is intensely pink, it might be cobalt.

To identify the compound completely, you will have to perform qualitative inorganic analysis. An introduction to the art is in the [Qualitative Analysis](#) (p. 60) section of this manual, and more advanced methods are available on the internet and in some advanced chemistry books.

5.8.3 Check for mercury

- If the liquid is not a base, dilute a small sample in water and add sodium hydroxide solution until POP turns pink.
- If a bright yellow precipitate forms, you probably have a mercury salt. Transfer all of the compound to a sturdy container with a well-sealing lid, wash the original container with minimal water once and add the washings to the storage container. Then wash the original container and anything the liquid touched thoroughly. Label the new storage container “Solution of unknown mercury salt, CONTAINS Hg!!, TOXIC! Do not use, Do not dump,” along with appropriate warnings in any local language(s), and find a safe and secure place for long term storage.

5.9 Identifying Unknown Solid Chemicals

This is not nearly as important as identifying unknown liquids for two reasons:

1. These chemicals are generally (though not always!) less dangerous.
2. Accidental spills are less dramatic.

The smallest containers are the most likely to hold dangerous chemicals, like mercury salts. It is best to just leave these ones alone.

What you can do is look at the solid and see if it matches any of the descriptions below. Color is much more useful for identifying solids.

- *Bright orange crystals* are likely a chromate or dichromate salt (toxic) or a ferricyanide salt (much less toxic). The latter will form an intensely blue precipitate with a small amount of Fe_2^+ , perhaps from iron (II) sulfate. Chromates form a yellow solution that turns orange on addition of acid while dichromates form an orange solution that turns yellow on addition of base.
- *Bright yellow, orange, or red powders* might be lead or mercury compounds. These are poisonous, the latter very. It also might be methyl orange powder.
 - Try to dissolve a small amount in water. Methyl orange will dissolve readily to give a bright orange solution, one that turns red in acid and yellow in base. Label the powder and keep it around.
 - If the salt dissolves but does not seem to be methyl orange, add sodium hydroxide until POP changes color.
 - A yellow precipitate suggests mercury. Label as with mercury compounds encountered above.
 - Most lead compounds are not soluble, and will not form a color in solution. Other mercury compounds are also insoluble. Label a container that might be lead or mercury as “possible lead or mercury compound, POISON,” and store it for the long haul.
- *A yellow powder insoluble in water* may also be sulfur. It should smell like sulfur. A small amount will dissolve in kerosene, and the dry powder will melt when heated in a spoon over a flame and then burn with a blue flame – producing sulfur dioxide, a poisonous gas. Do not heat an unknown yellow compound unless you are fairly sure it is sulfur.
- *Blue compounds* are often copper salts. These should have a green flame test.
- *Purple crystals or flakes* insoluble in water are probably iodine. Iodine will dissolve in kerosene to form a red solution.
- One of the few *green powders* is nickel carbonate.
- *Pink wet looking crystals* might be a cobalt compound. Heat them gently in a spoon and they should dehydrate to turn blue. The blue crystals should turn pink when dissolved in water. Cobalt is poisonous.
- *Crystals so purple they look brown or yellow* are probably potassium permanganate. They should form an intensely purple solution in water. Confirm as with potassium permanganate solution above.

- *White crystals and powders* are really hard to identify. Label them “unknown white powder/crystals” and move them to a safe and secure place.
- Flat dull *gray metallic ribbon* about 5 mm wide and 1 mm thick is probably magnesium metal. It should turn shiny if polished with steel wool. It will also burn with a very intense white light if lit in either a Bunsen burner or gas cigarette lighter. Hold it with tongs, and do not stare at the light.
- A *metal stored under oil* is probably sodium or potassium. If you are feeling adventurous, remove a sample and cut off a VERY small piece, perhaps 5 mm on a side. Both metals may be easily cut with a knife. Return the rest to the original container and seal it again. Then, add the piece of metal to an open container of water and stand back. Both react violently and generally send the piece of metal spinning around on a cushion of hydrogen gas. Potassium generally gets hot enough to ignite this gas which then burns with a lilac flame. If the hydrogen under sodium burns, it will be yellow. The water will become a solution of sodium or potassium hydroxide.

Part II

Laboratory Safety

Guidelines for Laboratory Safety

There is no excuse for laboratory accidents. Students and teachers get hurt when they do something dangerous or when they are careless. If you do not know how to use a substance or a tool safely, do not use it. If your students do not know how to use a chemical or a tool safely, do not let them use it until they do. Adopt a zero tolerance policy towards truly unsafe behavior (running, fighting, throwing objects, etc.) – first infraction gets students kicked out of class for the day. Explain the error to everyone to make sure that it is never repeated. If the same student errs again, expel him for longer. Make it clear that you will not tolerate unsafe behavior.

Remember, the teacher is responsible for everything that happens in the lab. If a student is hurt the teacher is to blame. Either the teacher did not understand the danger present, did not adequately prepare the laboratory or the lesson, did not adequately train the student in safe behavior, or did not offer adequate supervision. As a teacher, you must know exactly the hazards of your chemicals, tools, and apparatus. Explain these hazards clearly and concisely to your students before they touch anything.

The following rules are for everyone in the lab to follow – students, teachers, and visitors alike. We recommend painting them directly on the wall as most paper signs eventually fall down.

6.1 Basic Lab Rules

1. Wear proper clothes. For every practical, wear shoes. Sandals are not acceptable lab ware. If you are pouring concentrated chemicals, you need to wear safety goggles.
2. Nothing enters the mouth in the lab. This means no eating, no drinking, and no mouth pipetting.
3. Follow the instructions from the teacher. Obey commands immediately. Only mix chemicals as instructed.
4. If you do not know how to do something or what to do, ask the teacher.

In addition to these rules, we recommend a variety of guidelines for teachers and lab managers to keep the lab a safe place.

6.2 Specific Guidelines to Reduce Risk

1. Never use the following chemicals:
 - 1.1. Organic liquids, including:
 - 1.1.1. Benzene (C_6H_6)
 - 1.1.2. Chlorobenzene (C_6H_5Cl)
 - 1.1.3. Dichloromethane (CH_2Cl_2)
 - 1.1.4. Tetrachloromethane/carbon tetrachloride (CCl_4)
 - 1.1.5. Trichloroethane (CH_3CCl_3)
 - 1.1.6. Trichloromethane/chloroform ($CHCl_3$)
 - 1.2. Anything containing mercury:
 - 1.2.1. Mercury metal (Hg)
 - 1.2.2. Mercurous/mercuric chloride ($HgCl/HgCl_2$)
 - 1.2.3. Million's Reagent ($Hg + HNO_3$)
 - 1.2.4. Nestler's Reagent ($HgCl_2 +$ others)
 - 1.2.5. For more information about these chemicals, their risks, and what to do if you find them in your lab, see [Laboratory Safety: Dangerous Chemicals](#) (p. 27).

2. Do not make hazardous substances
 - 2.1. Chlorine gas - electrolysis of chloride salts, oxidation of chloride salts or hydrochloric acid by oxidizing agents such as bleach or potassium permanganate
 - 2.2. Chloroamines - ammonia with bleach. People have died mixing ammonia and bleach together when mixing cleaning agents.
 - 2.3. Hydrogen cyanide - cyanide salts, including ferro- and ferri-cyanide, with acids.
3. Avoid hazardous substances
 - 3.1. If you have a choice, use non-poisonous substances. To be a good teacher, the only poisons that you have to use are those required by the national exams. For all other activities, use less dangerous substances.
 - 3.2. Only give students small quantities of required poisons.
 - 3.3. For advice on handling the various required poisons, see Laboratory Management: Dangerous Chemicals.
4. Avoid explosions
 - 4.1. Never heat ammonium nitrate.
 - 4.2. Never heat nitrates in the presence of anything that burns.
 - 4.3. Never heat a closed container.
 - 4.4. If performing a distillation or other experiment with boiling or hot gases, make sure that there is always an unobstructed path for gases to escape.
5. Avoid fires
 - 5.1. Be careful!
 - 5.2. Keep all flammable materials away from flames. Never have the following very flammable chemicals in the same room as fire: propanone (acetone), ethyl ethanoate (ethyl acetate), diethyl ether.
 - 5.3. Keep stoves clean and in good working order. Do not douse stoves with water to extinguish them because the metal will corrode much faster (think kinetics). There is never a need for this. If the stove does not extinguish on its own, you should repair it so it does.
 - 5.4. Only use the appropriate fuel for a given stove. For example, never put petrol in a kerosene stove.
6. Avoid cuts
 - 6.1. Only use sharp tools when required, and design activities to minimize use of sharp tools.
 - 6.2. Keep sharp tools sharp. The only thing more dangerous than cutting with a sharp knife is cutting with a dull one.
 - 6.3. Use the right tool for cutting.
 - 6.4. Use as little glass as possible.
 - 6.5. Do not use broken glass apparatus. The last thing you want to deal with during a practical is serious bleeding. It is tempting to keep using that flask with the jagged top. Do not. Do not let anyone else use it either – break it the rest of the way.
 - 6.6. Dispose of sharp trash (glass shards, syringe needles) in a safe place, like a deep pit latrine.
7. Avoid eye injuries
 - 7.1. Students should wear goggles during any activity with a risk of eye injury. See the Materials: Apparatus section for suggestions on goggles. If you do not have the goggles necessary to make an experiment safe, do not do the experiment.
 - 7.2. Keep test tubes pointed away from people during heating or reactions. Never look down a test tube while using it.

- 7.3. Never wear contact lenses in the laboratory. They have this way of trapping harmful chemicals behind them, magnifying the damage. Besides, glasses offer decent (though incomplete) protection on their own.
8. Avoid chemical spills
 - 8.1. Teach students that if they get chemicals on their hands, they should wash them off immediately, without asking for permission first. Some students have been taught to wait for a teacher's permission before doing anything in the lab, even if concentrated acid is burning their hands. On the first day, give them permission to wash their hands if they ever spill chemicals on them.
 - 8.2. Also, teach students to tell you immediately when chemicals are spilled. Sometimes they hide chemical spills for fear of punishment. Do not punish them for spills - legitimate accidents happen. Do punish them for unsafe behavior of any kind, even if it does not result in an accident.
9. Use adequate protection with hazardous chemicals.
 - 9.1. Wear eye protection (see above). Find goggles or things that will substitute.
 - 9.2. Tie a cloth over your face when using concentrated ammonia or HCl. For the latter chemical, see below.
 - 9.3. Sulfuric Acid, H₂SO₄
 - 9.3.1. There is never any reason to ever use fully concentrated (18 M) sulfuric acid.
 - 9.3.2. For qualitative analysis, 5 M H₂SO₄ is sufficient for "concentrated sulfuric acid."
 - 9.3.3. Do not buy 18 M sulfuric acid. Battery acid will suffice for qualitative analysis and is a much safer (if still quite dangerous) source of sulfuric acid.
 - 9.3.4. If you already have 18 M sulfuric acid in your lab, just leave it. Battery acid is so cheap you can afford to get as much as you need.
 - 9.4. Hydrochloric acid, HCl
 - 9.4.1. Hydrochloric acid is never required.
 - 9.4.2. Do not buy concentrated hydrochloric acid. Use battery acid for all of its strong acid applications.
 - 9.4.3. When you need the reducing properties of HCl, for the precipitation of sulfur from thio-sulfate in kinetics experiments for example, make a solution with the proper molarity of chloride and H⁺ by dissolving sodium chloride in battery acid and diluting with water.
 - 9.5. Nitric acid, HNO₃
 - 9.5.1. The only time nitric acid is required is to dissolve certain carbonates in qualitative analysis. The first time you need nitric acid, prepare a large volume of dilute acid (e.g. 2.5 L) so that you do not need to handle the concentrated acid again.
 - 9.5.2. If many schools share a single bottle of concentrated acid, they should dilute it at a central location and transport only the dilute acid.
 - 9.5.3. Teach qualitative analysis of insoluble carbonates using copper, iron, or zinc carbonate – these will dissolve in dilute sulfuric acid.
10. Avoid mouth pipetting
 - 10.1. Never do it!
 - 10.2. This is a dangerous activity prohibited in every modern science laboratory.
 - 10.3. Use rubber pipette filling bulbs or plastic syringes.
 - 10.4. For more explanation, see Mouth pipetting in [Dangerous Techniques](#) (p. 33).
11. Be prepared
 - 11.1. Set aside a bucket of water for first aid.
 - 11.2. It should not be used for anything else.
 - 11.3. Have materials to fight fires and know how to use them.

- 11.4. A bucket of sand will work for any lab fire, is available to every school, and can be used by anyone.
12. Use good habits
 - 12.1. Hand washing
 - 12.1.1. Students should wash their hands every time they leave the lab.
 - 12.1.2. Always have water and soap available, ideally in buckets on a desk near the door.
 - 12.1.3. Even if students do not touch any chemicals when they are in the lab, they should still wash their hands.
 - 12.2. Clean all benches and chemicals
 - 12.2.1. Stray chemicals and contaminated apparatus has the potential for danger.
 - 12.2.2. Make sure students do not leave stray pieces of paper.
 - 12.2.3. Ensure all students clean the apparatus they use immediately after use.
 - 12.2.4. Have students to clean apparatus prior to use. It is not always possible to trust the students washed the apparatus after their last use.
 - 12.3. Tasting chemicals
 - 12.3.1. Students should never eat anything in the lab. Ever.
 - 12.3.2. Barium nitrate looks just like sodium chloride. Lead carbonate looks like starch.
 - 12.3.3. Do not bring food into the lab.
 - 12.3.4. If you use domestic reagents (vinegar, salt, baking soda, etc.) in the lab, label them and leave them in the lab.
 - 12.4. Smelling chemicals
 - 12.4.1. Be aware that many chemicals give off fumes that can produce obnoxious odors or be irritating to the respiratory system.
 - 12.4.2. Practicals involving nitrates, chlorides, ammonium compounds, and some sulphates produce harmful gases.
 - 12.4.3. Open the lab windows to maximize airflow.
 - 12.4.4. Kerosene stoves also produce noxious fumes - it is much better to use motopoa.
 - 12.4.5. If students feel dizzy or sick from the fumes, let them go outside to recover.
 - 12.4.6. Many lab reagents – ammonia, hydrochloric acid, nitric acid, ethanoic (acetic) acid – can cause serious damage if inhaled directly.
 - 12.5. Keep bottles and other apparatus away from the edge of the table. Twenty centimeters is a good rule.
 - 12.6. Cap reagent bottles when they are not in use.
 - 12.7. Do not do things you do not want your students to do. They are always watching, always learning.
13. Dispose of wastes properly
 - 13.1. See [Laboratory Management: Waste Disposal](#) (p. 38)

First Aid

In spite of taking all necessary precautions to avoid dangerous situations in the laboratory, emergencies may still arise which require the immediate use of First Aid techniques. Listed below are various types of possible emergencies, as well as some immediate treatment guidelines to follow until professional medical attention may be given to the victim. For treatment information relating to specific chemicals, refer to the section on [Dangerous Chemicals](#) (p. 27).

Cuts

1. Immediately wash cuts with lots of water to minimize chemicals entering the blood stream.
2. Then wash with soap to kill any bacteria that may have entered the wound.
3. To stop bleeding, apply pressure to the cut and raise it above the heart. If the victim is unable to apply pressure him/herself, remember to put something (gloves, a plastic bag, etc.) between your skin and their blood.
4. If the cut is deep (might require stitches) seek medical attention. Make sure that the doctor sees how deep the wound really is – you might do such a good job cleaning the cut that the doctor will not understand how serious it is.

Eyes

1. If chemicals get in the eye, immediately wash with lots of water.
2. Keep washing for fifteen minutes.
3. Remind the victim that fifteen minutes is a short time compared to blindness for the rest of life. Even in the middle of a national exam.

First and Second Degree Burns

1. Skin red or blistered but no black char.
2. Immediately apply water.
3. Continue to keep the damaged skin in contact with water for 5-15 minutes, depending on the severity of the burn.

Third Degree Burns

1. Skin is charred; there may be no pain.
2. Do not apply water.
3. Do not apply oil.
4. Do not removed fused clothing.
5. Cover the burn with a clean cloth and go to a hospital.
6. Ensure that the victim drinks plenty of water (one or more liters) to prevent dehydration.

Chemical Burns

1. Treat chemical burns by neutralizing the chemical.
2. For acid burns, immediately apply a dilute solution of a weak base (e.g. sodium hydrogen carbonate).
3. For base burns, immediately apply a dilute solution of a weak acid (e.g. citric acid, ethanoic acid). Have these solutions prepared and waiting in bottles in the lab.

Ingestion

1. If a student ingests (eats or drinks) the following, induce vomiting.
 - 1.1. Barium (chloride, hydroxide, or nitrate)
 - 1.2. Lead (carbonate, chloride, nitrate, oxide)
 - 1.3. Silver (nitrate)
 - 1.4. Potassium hexacyanoferrate (ferr[i/o]cyanide)
 - 1.5. Ammonium ethandioate (oxylate)
 - 1.6. Anything with mercury (see list above), but mercury compounds should just never be used.
2. To induce vomiting:
 - 2.1. Have the student put fingers into his/her throat
 - 2.2. Have the student drink a strong solution of salt water (use food salt, not lab chemicals)
3. Do not induce vomiting if a student ingests any organic chemical, acid, base, or strong oxidizing agent.
 - 3.1. These chemicals do most of their damage to the esophagus and the only thing worse than passing once is passing twice.
 - 3.2. Organic chemicals may be aspirated into the lungs if vomited, causing a sometimes fatal pneumonia-like condition.

Fainting

1. If a student passes out (faints), feels dizzy, has a headache, etc., move him/her outside until fully recovered.
2. Check unconscious students for breath and a pulse.
3. Perform CPR if necessary and you know how.
4. Generally, these ailments suggest that harmful gases are present in the lab – find out what is producing them and stop it. Kerosene stoves, for example, may emit enough fumes to have this effect.
5. See Sources of Heat in the Materials section for alternatives.
6. Chemicals reacting in drain pipes can also emit harmful gases. See Waste Disposal.

Electrocution

 – If someone is being electrocuted (their body is in contact with a live wire)

1. First disconnect the power source. Turn off the switch or disconnect the batteries.
2. If that is not possible, use a non-conducting object, like a wood stick or branch, to move them away from the source of electricity.
3. Unless there is a lot of water around, the sole of your shoe is non-conducting.

Seizure

1. If a student experiences a seizure, move everything away from him/her and then let the body finish moving on its own.

Dangerous Chemicals

8.1 Chemicals that should never be used in a school

8.1.1 Mercury and its compounds (e.g. Million's Reagent, Nestler's Reagent)

- Hazard: Toxic
- Route: Ingestion of solutions and salts; inhalation of vapors from the liquid metal. Mercury has a very low vapor pressure, but the vapors that do form are quite poisonous – inhalation is therefore a significant hazard.
- Use: Showing off to students, Million's reagent for biology (no longer used)
- Alternatives: Use the biuret test to detect proteins (1 M NaOH followed by 1% CuSO₄, a purple color is a positive result)
- Precautions if it needs handling (e.g. broken thermometers): Wear gloves or plastic bags on the hands.
- First aid: If ingested, induce vomiting at once. Administer activated charcoal. Seek medical attention.
- Disposal: If you find mercury or its compounds, keep them in sealed in a bottle and locked away. Label the bottle very clearly POISON, DO NOT OPEN, DO NOT DUMP and also include a strong warning in the local language(s). If you spill liquid mercury, ask everyone to leave and apply powdered sulfur immediately. Put on gloves and tie a cloth on your face. Open windows to increase ventilation. Then use pieces of cardboard to gather the mercury back together so you can seal it in a bottle. Apply powdered sulfur to any mercury that cannot be reached – e.g. cracks in the floor.

8.1.2 Benzene

- Proven carcinogen, toxic. A horrific and generally fatal form of cancer is associated with benzene exposure, with tumors appearing rapidly throughout body.
- Route: Can be fatal if ingested, especially if aspirated into the lungs (e.g. if mouth pipetting); also passes through skin(!)
- Use: Multi-purpose non-polar solvent. Less dense than water.
- Alternative: kerosene
- Precautions if it needs handling: Thick rubber gloves. It will pass rapidly through latex.
- Disposal: If you find a bottle of benzene, leave it sealed and in a secure place with a stern warning label. If a bottle breaks, evacuate the room and return only wearing a cloth over your face and thick rubber gloves. Absorb the benzene with cardboard, cotton wool, saw dust, rice hulls, or flour, transfer the mass to a dry place outside, add a significant amount of kerosene and burn completely. Benzene will combust on its own, but you want to make sure it burns hot enough that none simply vaporizes without combusting.

8.1.3 Tetrachloromethane (carbon tetrachloride)

- Hazard: Proven carcinogen. The chemical has killed students in both Tanzania and Kenya.
- Route: Ingestion can be fatal. Will pass through skin. Inhalation of vapors is quite dangerous.
- Use: Multi-purpose non-polar solvent. More dense than water.

- Trichloromethane (chloroform) is another non-polar solvent more dense than water, though still dangerous (listed in category two, below). If the density is not important, use kerosene. If the solvent must not be flammable, consider a different experiment.
- Precautions if it needs handling: Thick rubber gloves. It will pass rapidly through latex.
- First Aid: Seek medical attention immediately. Ask a medical expert if you should induce vomiting (the chemical can kill if absorbed through the stomach, but also if aspirated into the lungs when vomiting)
- Disposal: If you find a bottle of carbon tetrachloride, leave it sealed and in a secure place. If a bottle breaks, absorb the chemical with cotton wool and move the cotton to a place where it can off-gas away from people and other living things. Protect from rain and from leaching into the ground. Once the cotton is completely dry, douse with kerosene and burn it. Do not burn the chemical directly it used to be used in some fire extinguishers. On heating, it decomposes to release poisonous gases.

8.1.4 Other hazardous organic solvents

The following chemicals have hazards similar to if less severe than benzene and tetrachloromethane. None should ever be used in a school. Leave them sealed in their bottles. If a bottle breaks, follow the instructions listed with tetrachloromethane.

- Chlorobenzene
- Dichloromethane
- Trichloroethane

8.2 Dangerous chemicals that you might need to use

8.2.1 Ammonia (ammonium hydroxide solution)

- Hazard: The liquid burns skin, the fumes burn lungs, and reaction with bleach or any combination of chloride and oxidizer can form toxic chloroamine fumes.
- Use: Common bench reagent.
- Alternative: For a simple weak base, use carbonate or hydrogen carbonate.
- Precaution: Strongly prohibit mixing of different bench reagents. Neutralize waste completely before disposal. When pouring ammonia for distribution, wear cloth over your mouth and nose and work outside, upwind. To smell, waft carefully never inhale ammonia directly from a bottle!
- First Aid: In case of skin contact, wash with plenty of water followed by a dilute weak acid (vinegar or dilute citric acid) and more water. In case of eye contact, wash with water for at least ten minutes. If ingested, do NOT induce vomiting. In case of inhalation, move victim to fresh air. Seek medical attention if the victim does not recover quickly.
- Disposal: Save unused solution for another day. If you must dispose of it, add to several liters of water and leave in an open bucket in the sun, away from people and animals. The ammonia will evaporate, leaving water behind. The process is finished when the bucket no longer smells like ammonia.

8.2.2 Barium

- Hazard: Very poisonous if ingested in a soluble form (e.g. barium chloride, hydroxide, or nitrate). Note that barium carbonate will dissolve very quickly in stomach acid.
- Use: Preparation of hydrogen peroxide, test for sulfates, flame tests.
- Alternatives: hydrogen peroxide is often sold in pharmacies, sulfates may be confirmed with soluble lead salts (also poisonous!), and boron compounds (e.g. boric acid, borax) also produce a green flame color.

- Precautions: Distribute only in small quantities in bottles clearly labeled POISON. Also use the local word for poison, e.g. SUMU in Swahili. Collect all barium waste in a special container. This will require training students. Have a bottle of magnesium sulfate or sodium sulfate available for spills on skin or tables. Sodium sulfate can be prepared by neutralizing dilute sulfuric acid with sodium bicarbonate err on the side of excess bicarbonate. See Sources of Chemicals for magnesium sulfate.
- First Aid: If ingested, induce vomiting and administer activated charcoal if available. Go to the hospital. The material safety data sheet for barium chloride recommends use of sodium or magnesium sulfate under a doctor's direction. Chemically, this would precipitate barium sulfate, preventing absorption of the element. Magnesium sulfate is non-toxic, though will probably cause diarrhea.
- Disposal: Collect unused solutions for another day. Collect all waste in a large container and add dilute sulfuric acid until precipitation stops. Pour off most of the liquid and treat it as dilute acid waste. Use the remaining liquid to send the precipitate to the bottom of a pit latrine.

8.2.3 Chloroform (Trichloromethane)

- Hazard: used to render mammalian specimens unconscious; it has the same effect on humans. Also toxic if ingested. Passes through skin.
- Use: Knocking out dissection specimens, sometimes as a specialty non-polar solvent.
- Alternatives: Dissect dead specimens; use safer solvents.
- Precautions: Work in a well-ventilated space, like outside. NEVER, EVER MOUTH PIPETTE!
- First Aid: If ingested, go to the hospital. Do not induce vomiting unless instructed by a medical professional. If inhaled, immediately remove the victim to fresh air and sit (but not lie) him or her down in case of fainting. If the victim loses consciousness, go to the hospital. In both cases, monitor breathing and pulse. In case of skin contact, wash off immediately, and use soap as soon as it is available.
- Disposal: For the small amounts used in preparing specimens for dissection, allow the chemical to evaporate away from people and animals. For large amounts, e.g. if a bottle spills or breaks, evacuate the room and keep everyone away for at least one day. Return carefully, allowing more time if the room still smells like trichloromethane.

8.2.4 Concentrated Acids

(sulfuric, hydrochloric, nitric, ethanoic (acetic))

- Hazard: Serious skin burns, will blind in the eyes.
- Use: Often the starting material when preparing dilute acids for titrations or food tests. Also used directly in small quantities in chemical qualitative analysis.
- Alternatives: If any acid will suffice, use a safer weak acid, e.g. citric acid (best) or ethanoic (acetic) acid. If a dilute strong acid is required, use battery acid as a starting source of sulfuric acid. Note that many experiments calling for dilute hydrochloric acid work just as well with dilute sulfuric acid. Battery acid will also work for many experiments calling for concentrated sulfuric acid indeed it is about 5 M but will not work if one requires the dehydrating action of concentrated sulfuric acid. For such cases, consider other experiments. Note that battery acid is still quite dangerous it will burn holes in clothing and blind in the eyes.
- Precautions: Always have a full bucket of water and at least half a liter of sodium bicarbonate or other weak base solution available. Use thick rubber gloves and wear goggles. If you do not have these in your lab, go buy them. Whenever handling battery acid, wear goggles. Keep other people away when pouring concentrated acids. If you are using either concentrated hydrochloric, ethanoic (acetic), or nitric acid, work outside and stand upwind – the fumes corrode the lungs. Wear cloth over your mouth and nose. If a bottle ever falls and breaks, calmly but clearly ask everyone to

stop working and leave the room. Keep everyone upwind while the fumes blow away. Most of the acid will be consumed by reacting with cement. If the damage is significant, a building engineer should inspect the structure. Always pour acid into water when diluting. The heat of solvation of sulfuric acid especially is so exothermic that it can cause water to boil. If a small quantity of water is added to concentrated acid, it can boil so vigorously that it will cause acid to splash out of the container, on skin or into eyes. Finally, pour slowly from the bottle, always allowing air to enter as you pour. Otherwise, air will enter in sudden amounts, causing acid to exit the same way. This can cause it to splash back up at you.

- **First Aid:** For skin burns, promptly wash the affected area with a large amount of water. Then liberally apply a sodium bicarbonate or other weak base solution to the affected area. Then wash again with a large amount of water. Repeat until the burning sensation is gone. If the chemical ever gets in the eye, immediately apply sodium hydrogen carbonate solution to neutralize the acid in the eye, but nothing stronger – not carbonates and definitely not hydroxides. Then wash continuously with large amounts of water for ten minutes, longer if the eye still burns. Seek medical immediately. If swallowed, do not induce vomiting – the damage is done on the way down.
- **Disposal:** Add the concentrated acid to twenty or more times its volume of water and then add ash or baking soda until the mixture stops fizzing. The gas produced is carbon dioxide. Note that containers used to measure or hold concentrated acids often have enough residual acid to be dangerous. They should be submerged in a large container of water following use.

8.2.5 Diethyl Ether (ethoxyethane)

- **Hazard:** Can be fatal if aspirated into lungs. Also extremely flammable and a significant flash fire hazard. May also cause unconsciousness on inhalation.
- **Use:** Non-polar solvent
- **Alternative:** for a non-polar solvent, use kerosene. For a more volatile solvent, use paint thinner or lighter fluid. To demonstrate a rapidly evaporating substance, use propanone, ethyl ethanoate, or iso-propanol - note that all are also extremely flammable.
- **Precautions:** Never use alone (in general, do not use the lab alone). Distribute in bottles with lids or in beakers covered with e.g. cardboard to prevent evaporation. Under no circumstances should an open container of diethyl ether be in the same room as open flame. Only use in well ventilated spaces and encourage students to go outside if they feel at all drowsy or unwell.
- **Disposal:** See instructions on recycling of organic solvents to minimize the need for disposal. For what cannot be recovered, place where it can evaporate without being disturbed and without anyone downwind.

8.2.6 Ethandioic acid (oxalic acid), sodium/ammonium ethandioate (oxalate)

- **Hazard:** Poison
- **Use:** Volumetric analysis, oxidation-reduction reactions, qualitative analysis
- **Alternatives:** For its weak acid properties, use citric acid (best) or ethanoic (acetic) acid. For its reducing properties, use ascorbic acid or sodium thiosulfate.
- **First aid:** If ingested, induce vomiting and administer activated charcoal. Go to the hospital.
- **Disposal:** Collect unused solutions for another day. To dispose, add potassium permanganate solution slowly until the ethandioic acid / ethandioate lacks the power to decolorize it. At this point the compound should have been fully converted to carbon dioxide. If you used far excess oxidizing agent, neutralize with ascorbic acid prior to disposal.

8.2.7 Lead

- Hazard: Poisonous, toxic to many organs including the brain.
- Use: Unknown salt for qualitative analysis. Thus students must treat ALL unknown salts as potential lead compounds.
- Precautions: Unequivocally prohibit taste-testing of unknown salts. This seems obvious. Unfortunately, to many students it is not. Explain the hazard clearly – there are salts in the lab (e.g. barium compounds) where even a small taste can kill. Also, make sure students wash their hands.
- First Aid: If ingested, induce vomiting and administer activated charcoal.
- Disposal: Collect unused solids for another day. If the salt is soluble, dissolve all waste in a large container and add sodium chloride solution until precipitation stops. Send the precipitate to the bottom of a pit latrine. If the salt is already insoluble, drop it down.

8.2.8 Potassium hexacyanoferrate (potassium ferr[i/o]cyanide)

- Hazard: Reaction with concentrated acid releases hydrogen cyanide, the agent used in American gas chambers for executions. On inhalation, the cyanide enters the blood stream and binds cytochrome-c oxidase with a higher affinity than oxygen. Cellular respiration halts and tissues slowly die.
- Use: Qualitative analysis bench reagent.
- Precautions: Strongly prohibit mixing of different bench reagents. There are plenty of other dangerous combinations.
- First Aid: If a student seems to have trouble breathing, bring him/her outside immediately. If breathing remains difficult, seek medical attention. If the chemical is ingested, induce vomiting.
- Disposal: Dilute with plenty of water and send down the pipe. Make sure all acid waste is also diluted and neutralized.

8.2.9 Sodium hydroxide (and potassium hydroxide)

- Hazard: Concentrated solutions corrode metal, blacken wood, and burn skin. Even solutions as dilute as 0.1 M can blind if they get in the eyes. Note that this is a common concentration for volumetric analysis. Also note that the dissolution of sodium and potassium hydroxide are highly exothermic – rapid addition, especially to acidic solutions, can cause boiling and splatter. Finally, the salts are highly deliquescent and often turn to liquid if containers are not well sealed. This liquid is maximally concentrated hydroxide – the most dangerous form; do not dispose without neutralization.
- Use: Volumetric analysis, food tests, qualitative analysis bench reagent.
- Precautions: Use weak bases (carbonates and hydrogen carbonates) for volumetric analysis, provide students with goggles.
- First Aid: Treat spills and skin burns with a dilute solution of a weak base – ethanoic (acetic) or citric acid. If it gets in the eyes, immediately wash with a large amount of water. Continue washing for at least five minutes and seek medical attention if the eye still hurts.
- Disposal: Save for future use. To dispose, neutralize with citric acid or other acid waste and dump.

8.3 Chemicals that merit warning

8.3.1 Ammonium nitrate

Can explode (and shatter glassware, sending shards into eyes) if heated. Otherwise as innocuous as any other inorganic fertilizer.

8.3.2 Ethanol

The vapors are flammable, so ethanol should never be heated directly on a stove. If it must be warmed, it should be heated in a hot water bath. If the ethanol ignites anyway, do not panic. Cover the top of the ethanol container and smother the flame. Please note that methylated spirits have chemical additives that are poisonous, causing blindness, etc. Also, alcohol prepared for laboratory or industrial use is sometimes purified by extraction with benzene and probably contains traces of this potent carcinogen. Do not even think about drinking it.

8.3.3 Ethyl acetate/ethyl ethanoate

- Hazard: Extremely flammable
- Use: Solvent
- Precautions: Never open a bottle in the same room as an open flame.
- Disposal: Save for use as a solvent. If you must dispose, allow to evaporate away from people and fire.

8.3.4 Potassium permanganate

Powerful oxidizing agent. Do not mix with random substances. If you are trying something for the first time, use small quantities. Concentrated solutions and the crystals themselves will discolor skin, though the effect lasts only a few hours. This is the same stuff they sell in the pharmacies to prevent infections of cuts and surface wounds. Do not eat!

8.3.5 Propanone (acetone)

- Hazard: Extremely flammable
- Use: Solvent
- Precautions: Never open a bottle in the same room as an open flame.
- Disposal: Save for use as a solvent. If you must dispose, allow to evaporate away from people and fire.

Dangerous Techniques

Some common laboratory techniques are actually quite dangerous. Identify practices in your school that seem likely to cause harm and devise safer alternatives. Below are some examples of techniques often performed in the laboratory that can easily bring harm and alternative methods to do the same thing more safely.

Mouth Pipetting

Many schools use pipettes for titrations. Many students use their mouths to fill these pipettes. We strongly discourage this practice. The solutions used in ordinary acid-base titrations are not particularly dangerous. A little 0.1M NaOH in the mouth does not merit a trip to the hospital. Nevertheless, there are two pressing safety issues.

1. First, there are often other solutions present on the same benches the qualitative analysis test reagents for example that can kill if consumed. It seems like it would be a rare event for a student to mix up the bottles, but in the panic of the exam anything is possible.
2. Second, safety issue applies to the best students, those that continue on to more advanced levels. High level secondary and university students must measure volumes of the size fit for pipettes for chemicals that under no circumstances should be mouth pipetted. If a student is trained in mouth pipetting, she will continue with this habit in advanced level, especially in a moment of frustration when a pipette filling bulb seems defective, or if the school has not taught her how to use them, or if they are not supplied. Students have died in many countries from mouth pipetting toxins.

Fortunately, there is no reason to ever use a pipette in secondary school, even if rubber-filling bulbs are present. *Disposable plastic syringes are in every way superior to pipettes for the needs of students.*

- They have no risk of chemical ingestion.
- They are more accurate plastic is much easier to make standard size than glass; the pipettes available generally vary from their true volume, but all the syringes of the same model and maker are exactly the same volume.
- Plastic syringes are easier to use
- They are faster to use
- They are much more durable
- When they do break they make no dangerous shards
- They are much less expensive, by about an order of magnitude

Schools all over are already substituting plastic syringes for glass pipettes. For information on how to use these plastic syringes, please see [Use of a Plastic Syringe to Measure Volume](#) (p. 45).

Shaking Separatory Funnels

Separatory funnels are useful for separating immiscible liquids. They are also made of glass, very smooth, and prone to slipping out of students' hands. The liquids often used in these funnels can be quite harmful and no one wants them splashed along with glass shards on the floor. Much better is to add the mixture to a plastic water bottle, cap it tightly, and shake. After shaking, transfer the contents of the bottle into a narrow beaker. Either layer can be efficiently removed with a plastic syringe.

There are some cases where a separatory funnel remains essential. For secondary school, however, simply design experiments that use other equipment - and less harmful chemicals.

Looking Down into Test Tubes

May blind.

Part III

Laboratory Management

Classroom Management in the Laboratory

In addition to the guidelines recommended in the [Laboratory Safety](#) section, we recommend the following strategies to keep lab work safe, productive, and efficient.

Set lab rules

Before the first practical of the year, hold a short session to teach lab rules and lab first aid. Try to set a few clear, basic rules (like the four proposed in the Laboratory Safety section) instead of a long list of rules. Post these rules in the lab, and be consistent and strict in enforcing them with students and teachers.

Train students in basic techniques

For students just beginning laboratory-based education, you can probably teach each specific skill one at a time as they come up in experiments. For more advanced students, especially when they have different backgrounds in terms of laboratory experience, it is wise to spend several sessions practicing basic techniques (e.g. titrations for chemistry, using the galvanometer for physics, etc).

Have students copy the lab instructions before entering the lab

Do not let them into the lab unless they can show you their copy of the procedure, etc. Have a class dedicated to explaining the practical activity before the actual session. Bring a demo apparatus into the classroom.

Demonstrate procedures at the beginning

Do not assume that students know how to use a syringe or measure an object with calipers. If there are many new procedures, hold a special session before the practical to teach them the procedures. For titration, for example, hold a practice session in using burettes and syringes with water and food coloring. For food tests, explain and demonstrate each step to the students before holding a practical. It will save you a lot of trouble during the actual practical.

Have enough materials available

Always prepare 25-50 percent more reagent than you think you will need. Also have spare apparatus in case they fail in use. For example with physics, have extra springs, resistors, weights, etc. That said; do not make all of what you prepare immediately available to the students. As with sugar and salt, an obvious surplus increases consumption. If there is a definite scarcity of resources, it may be necessary to distribute the exact volumes necessary to each student. If you are doing this, make sure students understand that there is no more. In an exam, you might take unique objects, such as ID cards, to ensure each student receives her/his allotment only once.

Have enough bottles of reagent available

Even if only a small quantity of a reagent is needed, divide it into several bottles and put a bottle on each bench. If the volume is sufficiently small, distribute the chemical in plastic syringes. Do not use syringes for concentrated acids or bases because these chemicals can degrade the rubber in the syringe, there is a risk of the syringe jamming and the student squirting chemicals into eyes. The waiting caused by shared bottles leads to frustration and quarrels between groups. The last thing you want are students wandering around the lab and crowding to get chemicals.

Designate fetchers

If students must share a single material source, designate students to fetch materials. If a reagent needs to be shared among many students, explain this at the beginning, and have them come to the front of the room to get it rather than carrying it to their benches. This will help to avoid arguments and confusion over where the reagent is. If the students are in groups, have each group appoint one student to be in charge of fetching that chemical. However, it is much better to have the reagent available for each group at their workplace.

Teach students to clean up before they leave

This will save you a lot of time in preparing and cleaning the lab and it is just a good habit. Do not let students leave the lab until their glassware is clean and the bench is free of mystery salts and scraps of paper. If they do, consider not letting them in for the next practical. This might take assigned seats if you have many students. When they perform this clean up, make sure they follow whatever guidelines you have set for proper waste disposal.

Allow more time than you think you will need

What seems like a half hour experiment to you may take an hour for your students. Add fifteen minutes to a half hour more than you think will be necessary. If you finish early, you can have them clean up and then do a bonus demonstration.

Know the laboratory policies at the school

What is the policy on replacing broken equipment at the school? As a teacher, you need to know what you are going to do when the student drops an expensive piece of glassware. It is no fun to make up procedure while a student is in tears. What criteria will you use to determine if the student is “at fault?” Of course, this is less of an issue if you do not use glass apparatus.

Routine Cleanup and Upkeep

Like gardens and children, laboratories require constant attention. The Second Law of Thermodynamics does not sleep. The following advice should keep you on the winning side of the struggle against entropy.

Things to do immediately

- Remove broken glass from the floor. Use tools, like pieces of cardboard, not fingers!
- Neutralize and wash up chemical spills
- Replace chemical labels that have fallen off

The person who made the mess should clean it up. Make sure they know how before they are in a position to make a mess. If they are unable (e.g. hurt), have someone else do it. Review the incident with everyone present focusing on how to prevent similar accidents in the future. Avoid blaming other people – as the supervisor the accident is your fault; either you did not train someone well enough or your supervision of their behavior/technique was inadequate.

Things to do right after every lab use

- Return stock containers of chemicals to the store area. Only teachers should move glass bottles of corrosive or toxic chemicals. Remember to carry these with two hands!
- Transfer waste, including chemicals to be reused, into suitable storage containers
- Return apparatus to their proper places
- Put broken apparatus in a special place
- Wash off all benches / tables

The people who used the lab should do these things. If it is a lab class, the students should clean up the lab in that class period. If it is a group of teachers preparing experiments, the teachers should clean up their mess. Mess tends to grow with time, and no one wants to clean up someone else's mess.

Things to do either right after lab use or later that same day

- Transfer chemicals to be reused into more permanent and well labeled storage containers.
- Process all waste for disposal. See the instructions in [Waste Disposal](#) (p. 38).
- Remove all trash from the laboratory.

If done right after lab use, those who used the lab should do this work. If the work is done later anyone can take out the trash but waste should only be processed by someone who knows what (s)he is doing, and never working alone.

Things to do every week

- Sweep and mop the floor. Note that this should be done with brooms and buckets of water, or long handled mops, not by pushing cloth on the floor directly with hands.
- Wipe down the chemical storage area. Check for broken and leaking bottles.
- Ensure that sinks (if present) are not clogged. If a sink is clogged, either unclog it immediately or prevent use of the sink by physically obstructing the basin and also writing a sign. Signs by themselves are often insufficient. Barriers with signs tend to get moved.

You can do this work or you can train students to do it. Supervise their work while they are learning to make sure they use safe techniques. Ensure that students never work alone – even for mopping at least two students must be present at all times. Students should not work in the chemical storage area without a teacher present.

Waste Disposal

Introduction to waste management

Practical work produces chemical waste. Some of these wastes may be harmful to people, property or the environment if not properly treated before disposal. Regardless of where the waste will go – a sink, a flower bed, a pit latrine – the following procedures should always be followed.

Note, often there are unused reagents at the end of a practical. These are valuable and should be stored for use on another day. When storing left over reagents, label the container with:

1. The name of the compound, e.g. "sodium hydroxide solution"
2. The concentration, e.g. 0.1 M
3. The date of preparation, e.g. 15 June 2010
4. Important hazard information, e.g. "CORROSIVE, neutralize spills with weak acid."

Sometimes, there are used reagents that may be recycled. Recycling of chemicals reduces harm to the environment and saves money. Examples of chemical recycling are:

- Regenerating silver nitrate solution from qualitative analysis waste.
- Purification for reuse of organic solvents from distribution/partition law waste

In order to recycle these compounds, students must put their waste in designated containers. Specific instructions for chemical recycling follow in another section. Some wastes may be discarded without worry. These solutions may be poured down a sink or into a pit latrine. These include:

- The final mixture in the flask after a titration. This is neutral salt water.
- All of the wastes from food tests in biology. Note that unused reagents are not waste!

Finally, some wastes require special treatment. These wastes and their treatments follow.

Special instructions for certain wastes

Organic wastes

These are any substance that does not mix with water, for example kerosene, isobutanol, ether, chloroform, etc. These substances should be placed in an open container and left to evaporate down-wind from people and animals. Setting these wastes on fire is usually unnecessary and may be dangerous.

Strong acids

Sulfuric, hydrochloric, and nitric acid solutions will corrode sinks and pipes if not neutralized before disposal. These wastes should be collected in a special bucket during a practical. After the practical, bicarbonate of soda should be added until further addition no longer causes effervescence. The gas produced is carbon dioxide.

Strong bases

Sodium and potassium hydroxide solutions as well as concentrated ammonia solutions are also corrosive. These wastes should be collected in a different special bucket during a practical. After the practical, the waste should be colored with POP or a local indicator and acid waste should be added until the color changes. If there is more base waste than acid waste available to neutralize it, citric acid may be added until the color finally changes.

Heavy metals

Barium, lead, silver and mercury solution are highly damaging to the environment and may poison human or animal drinking water if disposed without treatment. Waste containing barium and lead, generally from qualitative analysis, should be collected in a special container during a practical. After the practical, dilute sulfuric acid should be added drop-wise until further addition no longer causes precipitation. At this point, soluble lead and barium will have been converted to insoluble lead sulfate and barium sulfate. These salts may then be disposed in a pit latrine. The waste should of course first be neutralized with bicarbonate of soda.

Waste containing silver should be collected in a different special container. Ideally, this waste will be treated to regenerate silver nitrate solution according to the instructions in the next section. If such recycling is infeasible, sodium chloride solution should be added drop-wise until further addition no longer causes precipitation. At this point, soluble silver will have been converted to insoluble silver chloride and may be disposed in a pit latrine.

There is no treatment for mercury solutions that may be safely performed in a secondary school. This fact combined with the extreme danger of using mercury compound in schools supports the recommendation that mercury compounds never be used. If mercury waste is ever discovered at the school, it should be placed in a well-sealed bottle labelled: MERCURY WASTE. TOXIC. DO NOT USE. MUST NOT ENTER THE ENVIRONMENT. SUMU KALI. USITUMIE NA USIMWAGE.

Strong oxidizers

Concentrated solutions of potassium permanganate, chromate, dichromate, hypochlorites (bleach), and chlorates should be reduced prior to disposal. Grind ascorbic acid (vitamin C) tablets to powder and add until the permanganate decolorizes, chromate and dichromate turn green or blue, and hypochlorites lose their smell. The resulting solutions may be safely disposed in a sink or pit latrine.

Solid waste

Solids clog pipes and should never be put into sinks. If the solid is soluble, dissolve it in excess waste and treat as solution waste. If the solid is insoluble, dispose into a pit latrine.

Unknown compounds

If you do not know what a compound is, you do not know what kind of treatment it requires prior to disposal. That solution that looks like water could be nitric acid, or mercury chloride solution. Before disposing of unknown compounds, please use the Guide to Identifying Unknown Chemicals in the appendix. Even if you cannot identify the compound with these instructions, you can use them to ensure that it is not dangerous to dispose.

Recycling Materials

Recycling Silver Nitrate

In many places, silver nitrate is the most expensive chemical used in a school laboratory. Silver nitrate is often used to confirm the presence of halide ions, which form insoluble precipitates with silver cations. The result of such tests are silver halide precipitates, themselves of little value.

- To regenerate the silver nitrate from these silver halides you must first reduce the silver halides to silver metal and then dissolve the metal in nitric acid. This process is easiest and most efficient with a large amount of material, so consider accumulating silver waste in a central location for many terms and perhaps from many schools.
- To reduce the silver halides, they must be in solution.
 - Add aqueous ammonia solution to the silver halides until they dissolve. You have formed a soluble silver - ammonia complex.
 - Add to the mixture a reducing agent. We have used both glucose and steel wool. Ascorbic acid, zinc metal, and sodium thiosulfate should in theory also work.
 - Heat the mixture until a metallic silver precipitate forms. It is OK if the solution boils.
- Once you believe all of the silver has precipitated as metal, decant the liquid, ideally filtering to separate all of the silver metal. Wash the silver metal in distilled (rain) water and filter again.
- Before adding nitric acid, make sure that the silver is dry.
- Then, add concentrated nitric acid slowly. The goal is to dissolve most but not all of the silver metal. If you dissolve all of the metal, you may have residual nitric acid in your silver nitrate solution that will make it ineffective for many uses.
- Decant the solution into a dark bottle - silver nitrate decomposes in light - and save the residual silver metal for the next time you do this.

Recycling Organic Waste

Organic chemicals are often expensive to purchase and difficult to dispose. Every effort should be made to collect organic wastes and recycle them. For the purpose of this discussion, organic chemicals are liquids insoluble in water, e.g. kerosene, ether, ethyl ethanoate (ethyl acetate), etc.

- Mixtures of multiple organic wastes require fractional distillation to separate. This is difficult and dangerous without the right equipment. Generally, if none of the organic chemicals in the mixture are particularly dangerous see the section on [Dangerous Chemicals](#) (p. 27) it is best to label the mixture mixed organic solvents, does not contain benzene or chlorinated hydrocarbons and keep it for future use as a generic solvent or for solubility activities.
- Mixtures of a single organic waste and water are inherently unstable, and given enough time will separate out into two layers. If the organic layer is on the bottom, it is probably di-, tri-, or tetrachloromethane, all dangerous chemicals. Follow the instructions in [Dangerous Chemicals](#) (p. 27). If the organic layer is on the top, simply decant it off. You might do this in two steps the first to separate only water from organic mixed with some water, and the second to separate from the latter fraction pure organic from a small volume that remains a mixture. Then the water can be discarded, the organic saved, and the small residual mixture left open to the air to evaporate.
- Often, mixtures of organic and aqueous waste contain a solute dissolved in both solvents. The solvent is said to be distributed or partitioned between these two layers. Examples of compounds that partition between an organic and an aqueous layer are organic acids, like ethanoic acid (acetic acid) and succinic acid, and iodine when the aqueous layer is rich in iodide (usually potassium iodide). To reuse the organic layer it is necessary to first remove the solute.

- If the solute is an organic acid, add a small amount of indicator to the mixture and then sodium hydroxide solution, shaking vigorously from time to time. The sodium hydroxide will react with the organic acid in the aqueous layer, converting it to the salt. As the concentration of the acid in the aqueous layer decreases, the distribution equilibrium will “push” acid dissolved in the organic layer into the aqueous layer, where it too is converted to salt. Eventually, all the organic acid will be converted to its conjugate base salt, which is only soluble in the aqueous layer, and the indicator will show that the aqueous layer is alkaline even after much shaking. Now the organic layer may be run off as above.
- If the solute is iodine, the organic layer should have a color due to the iodine, and thus it will be straightforward to know when the iodine is fully removed. If there is no color, add starch to give a black color to the aqueous layer. Then add ascorbic acid (crushed vitamin C tablets) to the mixture and shake vigorously until either the organic layer returns to its normal color or the starch-blackened aqueous layer turns colorless. At this point all of the iodine will have been reduced to iodide, soluble only in the aqueous layer. The clean organic layer may be run off as above. Sodium thiosulfate may be used instead of ascorbic acid.

If you require the final organic to be of quite high purity, repeat the treatment. A small amount of residual water may also be removed with use of a drying agent, such as anhydrous sodium sulfate or calcium chloride.

Industrial Ecology in the Laboratory

Industrial Ecology is a manufacturing design philosophy where the byproducts of one industrial operation are used as input material for another. The philosophy may be applied to a school laboratory with similar economic and environmental benefits.

The science teacher generally plans the term in advance, and thus has a good understanding of the experiments students will perform. Each experiment has input reagents and output products. Normally, each of these inputs has to be purchased, sometimes at great expense, and each of these outputs has to be disposed of properly. When the term is analyzed in aggregate, however, there should be many occasions where the outputs of one experiment may serve as the inputs for another.

For example, students learning about exothermic reactions might dissolve sodium hydroxide in water and measure the temperature increase. The students might then use this solution of sodium hydroxide for a titration against a solution of ethanoic acid. The product of this titration will be perfectly balanced sodium ethanoate solution, which may be used in qualitative analysis for detecting iron (III) salts.

To maximize the opportunities for such pairings of inputs and outputs, the teacher should identify the reagents and byproducts of all activities planned for the term. Teachers may even coordinate between subjects - the reaction between citric acid and sodium carbonate to make carbon dioxide in chemistry class produces a sodium citrate solution that may be used to prepare Benedict's solution for biology class.

Part IV

Laboratory Techniques in Chemistry

Use of the Beam Balance for Measuring Chemicals

Measuring Mass

A common tool for measuring mass is the triple beam balance. The name comes from the three parallel beams holding sliding weights. On one side of pivot point there is either a flat metal surface or a boom suspending a weighing tray. On the other side of the fulcrum, one the three parallel beams, are weights that the user slides closer or further to the pivot point. At the far end of the three beams is some kind of level indicator showing when the balance is in equilibrium or, if not, which side is too heavy.

Calibration

Calibrate the balance prior to use. Move all the sliding masses as far as they go towards the pivot point the zero mass mark. There are usually small groves that the sliders will fit snugly in. Make sure they are in those groves each slider except for the smallest should “click” into place. Take off any weight on the weighing tray and clean it completely. Look at the level indicator. There are two pieces. The right side not moving, but the left side of the level will move on addition of mass. The level shows the balance is calibrated when the level forms an unbroken horizontal line. If the balance is not level, there usually is a massive screw or a dial under the weigh pan. Turn it until the balance becomes level.

Weighing Chemical Samples

Triple beam balances are very accurate at measuring masses if used properly. Do not measure the chemicals directly on the metal weighing tray; use a piece of paper or glass. Many samples will react with the metal, permanently altering its mass and ruining the balance. Because the paper or glass you put the chemical on has mass, before adding any chemical you must weigh the paper or the glass first by itself. To weigh properly, move the sliders slowly until the balance becomes level or makes a horizontal line. Start with the smallest. If you reach the end before the balance equalizes, return the mass to its zero and start moving the next larger mass, one stop at a time. When the balance tips, move back one notch and again move the smallest slider until the balance is level. Record this mass by adding each of the slides together. The mass should be recorded to one decimal place beyond the units of the smallest lines on the balance. For example, if the lines each represent 0.1g, estimate the position of the slider to the nearest 0.01 g.

Sum the desired chemical mass with mass of the paper or glass you just measured. Move the sliders to this total mass. Now, slowly add the chemical onto the paper or glass until the beam balance becomes level. After weighing, transfer the chemical from the glass or paper into whatever will actually hold it. If you use a glass and plan for the sample to be dissolved, rinse the glass into your solution container to get every last bit of chemical into your solution. If you spill any chemical on the balance, clean it up immediately.

Simplified Procedure

- Clean and calibrate balance
- Use some paper or glass and move the sliders until level
- Sum the mass of desired chemicals to the mass of the paper or watch glass.
- Add the chemical until balance is level.
- Transfer chemical to receiving container.
- Clean up any spills

Other Important Tips

Many times, you will need to measure small masses, less than 5 grams. Unfortunately, the beam balance is not as accurate when measuring such small masses, as movements in the air can cause the balance to err. To overcome this problem, place an additional mass on the weighing tray along with the paper so that the effective mass is much larger. If you are using a glass container, this step is probably unnecessary. If you add another object to the tray, make sure that there is enough space still for your chemical!

Wind is another difficulty: find a place to weigh where the air is still, perhaps in a closed room or behind some sort of obstacle or screen.

If you need many samples each the same weight, use papers of identical size and therefore mass. This allows you to keep the sliding masses in the same place for each weighing.

If you are measuring a deliquescent chemical (one that takes in water from the air, e.g. sodium hydroxide, iron (III) chloride, etc) work efficiently, but remain careful not to spill. Close the stock chemical bottle as soon as possible after use. Measure the chemical on glass rather than paper if possible as the paper often absorbs the solution that forms as the chemical deliquesces.

Finally, make sure that the volume of substance you are measuring will physically fit on your paper or glass. For volumes greater than 20g of most substances, consider using a beaker or plastic container. For volumes 100g or greater, you almost certainly need a wide mouthed and high walled vessel to hold it all. Look at the volume of substance in a contain of known mass to have an idea of how much space your sample will occupy.

Use of a Plastic Syringe to Measure Volume

Safety First

Syringes are probably the best means of transferring specific volumes. They are also very safe – if used correctly. First, many syringes come with sterile needles in the same package. If this is the case, open the packages yourself and collect the needles. Never provide students with both syringes and needles. Syringe needles are designed to inject compounds into the bloodstream. Many laboratory chemicals can be very toxic if injected into the blood, and any injection done improperly carries significant risk of serious infection. Laboratory syringes should be used without the needles. If you decide to keep the syringe needles for tools (e.g. optical pins, dissection pins), store them in a well labeled container. If you decide to not keep the syringe needles, dispose of them in a sharps bin at a health center (best) or in a pit latrine.

Laboratory syringes should never be used for anything other than work in the laboratory. They should never leave the laboratory. Do not let students play with the syringes like squirt guns or point them at students' eyes even when empty. The mantra for all gun users – treat every gun like a loaded gun – should apply to syringes. They should be held with the nozzle pointed down.

Anyone working with organic solvents or concentrated acids/bases should wear goggles, whether or not syringes are involved.

Measuring Volume

There are two ways to use a syringe. The second is superior.

Direct Measure

Place the syringe in the solution you want to measure. Push the plunger completely in to remove all air. Draw the plunger back beyond the desired volume. Use the front of the rubber plunger to read the volume measured. Slowly push the plunger in until the rubber reaches the desired volume. Remove the syringe from the liquid being measured and transfer the liquid to the desired receptacle.

This method is a poor way to use the syringe. First of all, it is difficult to remove all the air bubbles from syringes. You will push the plunger in and out many times and still not be free of the bubbles. Often students turn the syringe upside-down and try pushing the bubbles up and out. While this effectively removes air, this method is likely to eject chemicals out into a student's eye.

In addition, using the rubber stopper to measure is surprisingly difficult. It is hard to see the volume markings, and the curvature of the rubber can cause confusion. Also, the refractive index of water is different than air, introducing additional error. Finally, if this method is used to measure organic solvents or concentrated solvents, these chemicals will react with the rubber in the syringe. This will make the rubber sticky and difficult to draw in and out. This makes the likelihood of an accident even higher. Therefore, we do not recommend this method for measuring volume with a syringe.

Air Bubble Method

Before putting the syringe into the solution you want to measure, draw back the plunger so it holds about 1 mL of air. Now put the syringe in the solution. Draw the plunger back beyond the desired volume. This time, there will be a large air bubble between the rubber and the top of the solution. Hold the syringe about the liquid being measured and push down the plunger until the top of the liquid inside is at the desired volume. Make sure that the top level of the liquid is level with your eye to prevent parallax error. Hold the container of liquid up so liquid exiting the syringe does not fall a long distance and splatter. Transfer the measured volume to its receptacle.

This method is the preferred manner of using a syringe. The air bubble allows for easier and more exact volume measurements. In addition, this method can be used with concentrated chemicals and organic

solvents. The air bubble does not allow these chemicals to come in contact with the rubber, at least on the initial measure. The rubber will start to react with the residue, and without prompt cleaning this can destroy the syringe.

Cleaning Syringes After Use

Like all lab equipment, syringes need to be cleaned after use. Fill a beaker or other open mouth container with water. Draw water into the syringe and push it out. Repeat 2 or 3 times. If you used the syringe to measure an organic solvent, wash the syringe thoroughly in soapy water and then rinse in ordinary water until all the soap is removed.

A Note About Auto-Disable Syringes

Almost all currently available syringes are marketed as auto-disable or safety syringes. These syringes have two mechanisms to prevent their reuse. First, if the plunger is completely depressed it will catch and the syringe will be rendered useless. Secondly, if the plunger is pulled out of the syringe tube the plunger shaft will detach from the plunger head, thus rendering the syringe useless. To allow the syringes to be reused as laboratory equipment, first take the wooden end of a matchstick and push it into the syringe tip to destroy the hooks that catch the plunger. This allows the syringe to be completely depressed and reused multiple times. To deal with the second mechanism, care should be taken not to completely remove the plunger from the syringe tube.

It is important to inform students of the proper use and handling of these newer auto-disable syringes.

Measures of Concentration

Molarity (M)

Molarity is the number of moles of substance per liter of SOLUTION. Note that molarity is not the number of moles of substance per liter of solvent (e.g. water), although practically these are very similar. A molar solution has a concentration of 1 M.

Density and percent purity

These measurements are used to find the concentration of stock acid solutions. The acid bottle should list two pieces of information: the density of the acid in $\frac{g}{cm^3}$ or $\frac{kg}{dm^3}$, and the percent purity of the acid. The percent purity tells you what portion of the density is due to the acid itself, and what portion is due to water or impurities. See the chapter on Calculating the Molarity of Bottled Reagents to see how this information is used to find molarity.

Percent by mass

The percent by mass of a solute ($\%$ or w/w or m/m) is the grams of the solute in 100 g of solution. Now, for most practicals, solutions do not need to be very precise. Thus it is acceptable to let the percent by mass just be the grams of solute in 100 ml of water. This makes these solutions much faster to prepare.

Such approximation may not suffice for more advanced work. Consider a 1% by mass solution of copper (II) sulfate. This solution should contain 1 g of $CuSO_4$ in 100 g of solution. This means that the mass of water is $100g - 1g = 99g$. By assuming that the density of water before adding the solute is $1g/mL$, we find that 99 mL of water must be combined with 1 g of $CuSO_4$ to make the solution. This difference matters if you are making, say, a solution of iron sulfate on which students will perform a redox titration.

Percent by volume ($\%$ or v/v)

Percent by volume is used to measure concentration for a mixture of a liquid chemical and water. It is equal to the volume of the chemical divided by the volume of the solution.

Example: What volume of pure ethanol must be used to make 500 mL of a 70% ethanol solution?

Answer: 70% ethanol means 70 mL ethanol per 100 mL of solution. Thus, the required volume is:

$$\text{volume of pure ethanol} = \text{total solution volume} \times \text{desired fraction ethanol}$$

$$V = 500ml \times 0.70$$

$$V = 350mL$$

Normality (N)

The normality of the solution is closely related to the molarity. For many solutions, the normality IS the molarity. Normality is generally used in older books to refer to acid and base solutions. Technically, it is the "moles of equivalent" per liter. So for an acid solution, it is the moles of H^+ per liter of solution. For a base solution, it is the moles of H^+ that may be neutralized per liter of solution. For example, 1 M HCl has one mole of H^+ per liter of solution. Thus 1 M HCl is also 1 N. However, 1 M H_2SO_4 provides TWO moles of H^+ per liter of solution, so 1 M H_2SO_4 is 2 N. In a similar vein, 1 M NaOH is 1 N, but 1 M Na_2CO_3 is 2 N.

Molality

Molarity is the number of moles of solute per liter of solution. **Molality** is the number of moles of solute per kilogram of SOLVENT. In dilute aqueous solutions, the molarity and the molality are almost the same.

Some Notes on Calculations

Many textbooks and student notebooks transcribed from them feature equations that range between novel and obtuse to the American eye. Here are two very common equations that you should be aware of, mostly because the teachers that mark exams expect students to use them.

First off, the equation that often defined molarity as $M = \frac{\text{concentration}}{\text{molecular mass}}$. That is, molarity is equal to the concentration in grams per liter divided by the molecular mass of the solute (in grams per mole).

Second, the central equation for titration calculations:

$$\frac{(M_A)(V_A)}{(M_B)(V_B)} = \frac{n_A}{n_B}$$

A refers to the acid, B to the base, M to molarity, V to volume, and N to the stoichiometric coefficient of the acid/base in the reaction equation.

This said, there is a strong case to be made for teaching students equations that rely on an understanding of moles rather than encouraging them to memorize antiquated methods. The above equations essentially try to circumvent the need to think about moles. If you are teaching ordinary level, teach your students moles, and then show how the molarity and titrations equations come about from this unifying concept. If students can reduce every quantitative problem to moles, they will have a better understanding of the manipulations they are performing.

Calculating the Molarity of Bottled Liquids

You need three pieces of information to perform this calculation:

1. The molecular mass of the acid. This is usually written on the bottle and can be easily calculated if it is not. For concentrated acids: sulfuric acid is 98 g/mol, hydrochloric acid is 36.5 g/mol, ethanoic acid is 60 g/mol, and nitric acid is 63 g/mol
2. The percent purity of the compound. This might be expressed as a percent (e.g. 31% HCl), with the symbol m/m (e.g. $m/m = 68\%$), or with the word purity ("98% pure"). If you cannot find this information, see the note at the end.
3. The density (ρ) or specific gravity (s.g.) of the acid. This should be in grams per cubic centimeter (cc or cm^3).

Then, you can calculate the molarity of your concentrated acid with this formula:

$$\text{molarity} = M = \frac{(\text{percent purity})(\text{density})(1000 \frac{\text{cm}^3}{\text{L}})}{\text{molecular mass}}$$

For example, the molarity of an acid bottle labeled H₂SO₄, 98%, s.g. 1.84 we would calculate:

$$\text{molarity} = M = \frac{(0.98)(1.84 \frac{\text{g}}{\text{cm}^3})(1000 \frac{\text{cm}^3}{\text{L}})}{98 \frac{\text{g}}{\text{mol}}}$$

Note that we used 0.98 for 98%. Convert all percents to decimals.

Once you do this work, take out a permanent pen and label your stock bottle with its molarity. Then no one needs to do this calculation again.

Note: since you will correct the concentration of your solutions with relative standardization, you really just need to know the approximate molarity of your liquid stock reagent. For new bottles of concentrated acid, you may assume that sulfuric acid is about 18 M, hydrochloric acid is about 12 M, and that both nitric acid and ethanoic (acetic) acid are about 16 M. Battery acid should be 4.5 M H₂SO₄.

Preparation of Solutions

For many exercises, solutions do not need to be prepared accurately. Even a 50% error in the preparation will still allow an effective experiment. For other activities, the solutions should be prepared with a great deal of accuracy. This is especially true for volumetric analysis and conductivity experiments. This section deals with the preparation of solutions when accuracy counts.

Measure the Water

- Calculate the total volume of solution you need to prepare. For example, if you are doing a practical with 100 students and each requires 150 mL of solution you should make at least 15 L of solution. Making 20 L is probably wise, to have some extra.
- Find a container large enough for the total volume. Plan ahead to ensure you have a large enough container.
- Add the required volume of ordinary water.
- If your syllabus encourages you to often practice acid-base titrations, designate a pair of suitably large buckets as your permanent ACID and BASE buckets and label them as such with a permanent pen. Then, use a 1 liter container to add water to these buckets, one liter at a time. Use the permanent pen to mark the water height after each liter. Use these marks when adding water to make solutions. Round up the volume you need to the nearest liter (e.g. 71 students \times 200 mL per student = 14.2 L, so make 15 L). As long as you use relative standardization when you finish preparing the solutions, any errors you make when measuring the volume will not affect your students' results.
- Distilled water is rarely necessary. If you are preparing solutions for volumetric analysis, read the section on Relative Standardization to learn how to correct small errors caused by the composition of the tap or river water. If the water forms a precipitate when making solutions of hydroxide or carbonate, allow the precipitate to settle and decant the solution. If you are making a dilute solution, you might add hydroxide or carbonate gradually with mixing until precipitation stops and then add the amount you actually need to the liquid after decantation. If the only water supply is muddy, let the dirt settle and decant or use a cloth filter. If the particles are very fine, add a chemical like potassium aluminum sulfate (alum) or iron sulfate to precipitate the dirt. If you think that you do need distilled water, rain water is almost always sufficient.

What comes next depends on the nature of your stock chemical. In general, there are two kinds of solutions:

- Solutions prepared from solid stock chemicals, e.g. sodium hydroxide, citric acid
- Solutions prepared from liquid stock chemicals, e.g. sulfuric acid

Preparing solutions from solid stock chemicals

- Calculate the amount of solid chemical required. If the instructions give the required concentration in grams per liter (e.g. 4 g/L NaOH solution), multiply the total volume by the required concentration (e.g. 4 g/L \times 10 L = 40 g). If the instructions give the required concentration in molarity or moles per liter (e.g. 0.1 M NaOH solution), multiply the required molarity by the molecular mass of the compound to find the required concentration in grams per liter (e.g. 0.1 mol/L \times 40 g/mol = 4 g/L). Then, multiply the required concentration by the total volume (4 g/L \times 10 L = 40 g).
- Use a balance to weigh the solid chemical. Remember to weigh the chemical in a plastic container or on a sheet of paper and not on the scale pan directly. Some chemicals (e.g. sodium hydroxide) react with the metal pan. If you are unfamiliar with how to use a balance, read [Use of the Beam Balance for Measuring Chemicals](#) (p. 43). If you do not have a balance, read the section on [Preparation of Solutions Without a Balance](#) (p. 52).

- Carefully add the solid chemical to the water and stir with something unreactive (e.g. glass rod, broken burette, thick copper wire) until it has completely dissolved.

Preparing solutions from liquid stock solutions

- Calculate the amount of liquid chemical required. To do this, you need to know the molarity of your stock chemical. See the section on [Calculating the Molarity of Bottled Liquids](#) (p. 49). If the instructions give the required concentration in molarity or moles per liter, use the dilution equation to calculate the amount of concentrated required:

$$(M_{concentrated})(V_{concentrated}) = (M_{dilute})(V_{dilute})$$

rearranging

$$V_{dilute} = \frac{(M_{concentrated})(V_{concentrated})}{M_{dilute}}$$

For example, if you need 10 L of 0.1 M HCl and you have 12 M stock solution, the required volume of concentrated acid is

$$V_{dilute} = \frac{(12 \text{ M})(10 \text{ L})}{0.1 \text{ M}}$$

- If the instructions give the required concentration in grams per liter, divide this concentration by the molecular mass to get molarity (e.g. $\frac{3.65 \text{ g/L}}{36.5 \text{ g/mol}} = 0.1 \text{ mol/L}$) and then use the dilution equation as above.
- Use a DRY measuring cylinder to measure the required amount of liquid chemical. Concentrated acids may be measured in standard lab grade plastic measuring cylinders there is no need for glass. If you do not have a measuring cylinder, you can use a plastic syringe. Be sure to use the Air Cushion Method for measuring volumes with syringes (see the section on [Use of a Plastic Syringe to Measure Volume](#), p. 45) concentrated acids will rapidly corrode the rubber in the syringe on contact, causing the syringe to jam and become dangerous. Also, please read the description of [Concentrated Acids](#) in [Dangerous Chemicals](#) (p. 29).
- Carefully pour the liquid chemical into the container of water. Stir with something non reactive (glass rod, broken burette, thick copper wire) for about one minute.

Then, for all volumetric analysis solutions, use the instructions in the [Relative Standardization](#) (p. 53) section to perfect the mole ratio of your solutions.

Preparation of Solutions Without a Balance

The procedure in the section on [Relative Standardization](#) (p. 53) allows us to do something seemingly impossible – prepare solutions for volumetric analysis that allow students to get perfect results without using either a balance or volumetric glassware in the preparation. All that you have to do is make two solutions that are close, and then use several cycles of relative standardization to perfect the molarity ratio.

To measure volume, we can use marks on plastic water bottles as described in the entry for volumetric glassware in the [Local Materials List](#) (p. 131) section.

To make 0.05 M sulphuric acid (equivalent to 0.1 M HCl) for fifty students

1. Put 9.9 liters of water into a bucket.
2. Add 110 mL of battery acid. This may be accomplished easily by filling a 10 mL plastic syringe eleven times.

To make 0.033 M citric acid (equivalent to 0.1 M HCl) for fifty students

1. Put 10 liters of water into a bucket.
2. Add 64 g of citric acid. In the absence of a balance, one can often have $\frac{1}{8}$ of a kilogram (125 g) measured in the market. Dissolve this in 20 L of water to produce a 0.033 M solution.

To make 0.1 M sodium hydroxide for fifty students

1. Put 10 liters of water into a bucket.
2. Add 40 g of caustic soda. In the absence of a balance, use a plastic syringe to find the volume of a plastic spoon. Fill the spoon with caustic soda and use it to add a total of 19 cm³ or mL caustic soda knowing the volume of each spoonful. Please read the safety note in [Dangerous Chemicals](#) (p. 27).

To make 0.1 M sodium hydrogen carbonate for fifty students

1. Put 10 liters of water into a bucket.
2. Add 84 g of bicarbonate of soda. In the absence of a balance, find the volume of a spoon as above and add 39 cm³ or mL of bicarbonate of soda. Alternately, if 8.33 liters of solution is sufficient, measure this volume of water and then add one whole box of bicarbonate of soda. A box is 70 g.

Relative Standardization

Preparing large volumes of solution is difficult with great accuracy. Relative standardization is a technique to correct the concentration of solutions so that they give the correct results for practical exercises. Note that this technique is only useful in educational situations where the purpose is to prepare a pair of solutions for titration that give an answer known by the teacher. In scientific research, the aforementioned technique – absolute standardization – is used because the concentration of one of the solutions is truly unknown.

All schools should use relative standardization to check the concentration of the solutions they prepare for the national examinations. This ensures that the tests measure the ability of the students to perform the practical, and not the quality of the school's balance, water supply, glassware, etc. While useful for all schools, relative standardization is particularly helpful for schools with few resources, as it allows the preparation of high quality solutions with extremely low cost apparatus and chemicals.

General Theory

The principle of a titration is that the chemical in the burette is added until it exactly neutralizes the chemical in the flask. If the two chemicals react 1:1, e.g.

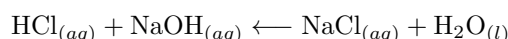

then exactly one mole of the burette chemical is required to neutralize one mole of the chemical in the flask. If the two chemicals react 2:1, e.g.

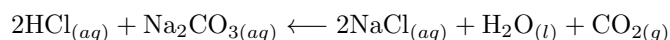

then exactly two moles of the burette chemical is required to neutralize one mole of the chemical in the flask. Let us think of this reaction as a mole ratio.

$$\frac{\text{moles of } A}{\text{moles of } B} = \frac{n_A}{n_B}$$

Where n_A and n_B are the stoichiometric coefficients of A and B respectively.

$$\text{moles} = \text{molarity} \times \text{volume} = M \times V \text{ (so long as } V \text{ is measured in liters)}$$

By substitution,

$$\frac{(M_A)(V_A)}{(M_B)(V_B)} = \frac{n_A}{n_B}$$

A student performing a titration might rearrange this equation to get

$$M_A = \frac{(n_A)(M_B)(V_B)}{(n_B)(V_A)} \text{ or } M_B = \frac{(n_B)(M_A)(V_A)}{(n_A)(V_B)}$$

As teachers, however, we care with something else: making sure that our students find the required volume in the burette. Solving the equation for V_A we find that

$$V_A = \frac{(n_A)(M_B)(V_B)}{(n_B)(M_A)}$$

As n_A and n_B are both set by the reaction, as long as we use the correct chemicals there is no problem here.

V_B is measured by the students – it is the volume they transfer into the flask. As long as the students know how to use plastic syringes accurately, they should get this value almost perfectly correct.

The remaining term, $\frac{M_B}{M_A}$ is for the teacher, not the student, to make correct. If we prepare the solutions poorly, our students can do everything right but still get the wrong value for V_A . It is very important that we ensure that our solutions have the correct ratio of $\frac{M_B}{M_A}$ so that the exercise properly assesses the ability of our students.

Many people look at this ratio and decide that they therefore need to prepare both solutions perfectly, so that M_B and M_A are exactly what is required. This not true. The actual values for M_B and M_A are not important; what matters is the ratio M_B to M_A !

For example, if the titration requires 0.10 M HCl and 0.10 M NaOH, our expected mole ratio is:

$$\frac{M_{HCl}}{M_{NaOH}} = \frac{0.10}{0.10} = 1$$

Preparing 0.11 M HCl and 0.09 M NaOH will cause the students to get the wrong answer:

$$\frac{M_{HCl}}{M_{NaOH}} = \frac{0.11}{0.09} = 1.22$$

However, preparing exactly 0.05 M HCl and 0.05 M NaOH results in the same molar ratio:

$$\frac{M_{HCl}}{M_{NaOH}} = \frac{0.05}{0.05} = 1$$

Thus the students can get exactly the right answer if they use the right technique even though neither solution was actually the correct concentration.

How can we ensure that we have the correct molar ratio between our solutions? Titrate your solutions against each other. If the volume is not the expected value, one of your solutions is too concentrated relative to the other. You can calculate exactly how much too concentrated and add the exact amount of water necessary to perfect the ratio. This process is called relative standardization, because you are standardizing one solution relative to the other.

Procedure for Relative Standardization

In some titrations the acid is in the burette and in some it is the base is in the burette. So let us not use “acid” and “base” to refer to the solutions, but rather “solution 1” and “solution 2” where solution 1 is the solution measured in the burette and solution 2 is measured by pipette (syringe).

You should have prepared a bucket or so of each. The volume you have prepared is V_1 liters of solution 1 and V_2 liters of solution 2. Titrate the solutions against each other. Call the volume you measure in the burette “actual titration volume” You know the desired molarity of each solution, so from the above student equations you can calculate the burette volume you expect, which you might call “theoretical titration volume.” After the titration, there are three possibilities. If the actual titration volume equals the theoretical titration volume, your solutions are perfect. Well done.

If the actual titration volume is smaller than the theoretical titration volume, solution 1 is too concentrated and must be diluted. Use the ratio:

$$\frac{V_1 \text{ (before dilution)}}{V_1 \text{ (after dilution)}} = \frac{\text{actual titration volume}}{\text{theoretical titration volume}}$$

If the actual titration volume is larger than the theoretical titration volume, solution 2 is too concentrated and must be diluted. Use the ratio:

$$\frac{V_2 \text{ (before dilution)}}{V_2 \text{ (after dilution)}} = \frac{\text{theoretical titration volume}}{\text{actual titration volume}}$$

After diluting one of your solutions, repeat the process. After a few cycles, the solutions should be perfect. Remember that the volume “before dilution” is the volume actually in the bucket, so the amount you made less the amount used for these test titrations.

Chemistry Practicals

Though this section is focused on the practicals, the information provided can be useful in general laboratory experiments. Please refer to the Chemistry Practicals section in the NECTA Manual for complete information and sample practicals for Chemistry.

21.1 Volumetric Analysis

21.1.1 Volumetric Analysis Theory

Volumetric Analysis is a method to find the concentration (molarity) of a solution of a known chemical by comparing it with the known concentration of a solution of another chemical known to react with the first. For example, to find the concentration of a solution of citric acid, one might use a 0.1 M solution of sodium hydroxide because sodium hydroxide is known to react with citric acid.

The most common kinds of volumetric analysis are for acid-base reactions and oxidation-reduction reactions. Acid-base reactions require use of an indicator, a chemical that changes color at a known pH. Some oxidation-reduction reactions require an indicator, often starch solution, although many are self-indicating, (one of the chemicals itself has a color).

The process of volumetric analysis is often called *titration*.

21.1.2 Substituting Chemicals in Volumetric Analysis

Theory

The volumetric analysis practical exercises sometimes call for expensive chemicals, for example potassium hydroxide or oxalic acid. As the purpose of exercises and exams is to train or test the ability of the students and not the resources of the school, it is possible to use different chemicals as long as the solutions are calibrated to give equivalent results. For example, if the instructions call for a potassium hydroxide solution, you can use sodium hydroxide to prepare this solution. It will not affect the results of the practical – if you make the correct calibration. How to calibrate solutions when substituting chemicals is the subject of this section.

Technically, only two chemicals are required to perform any volumetric analysis practical: one acid and one base. The least expensive options are sulfuric acid, as battery acid, and sodium hydroxide, as caustic soda. To substitute one chemical for another in volumetric analysis, the resulting solution must have the same normality (N).

- For all monoprotic acids (HCl, ethanoic acid), the normality is the molarity.
Example: 0.1 M ethanoic acid = 0.1 N ethanoic acid
- For diprotic acids (sulfuric acid, ethandiotic acid), the normality is twice the molarity, because each molecule of diprotic acid brings two molecules of H⁺.
Example: 0.5 M sulfuric acid = 1.0 N sulfuric acid
- For the hydroxides and hydrogen carbonates used in ordinary level (NaOH, KOH, NaHCO₃), the normality is the molarity.
Example: 0.08 M KOH = 0.08 N KOH
- For the carbonates most commonly used (Na₂CO₃, Na₂CO₃ · 10H₂O, K₂CO₃), the normality is twice the molarity.
Example: 0.4 M Na₂CO₃ = 0.8 N Na₂CO₃

Substitution Calculations

When instructions describe solutions in terms of molarity, calculating the molarity of the substitution is relatively simple. For example, suppose we want to use sulfuric acid to make a 0.2 M solution of ethanoic acid. 0.2 M ethanoic acid is 0.2 N ethanoic acid which will titrate the same as 0.2 N sulfuric acid. 0.2 N sulfuric acid is 0.1 M sulfuric acid, and thus we need to prepare 0.1 M sulfuric acid.

When instructions describe solutions in terms of concentration ($\frac{\text{g}}{\text{L}}$), we just need to add an extra conversion step. For example, suppose we want to use sodium hydroxide to make a 14.3 $\frac{\text{g}}{\text{L}}$ solution of sodium carbonate decahydrate. 14.3 $\frac{\text{g}}{\text{L}}$ sodium carbonate decahydrate is 0.05 M sodium carbonate decahydrate which is 0.1 N sodium carbonate decahydrate. This will titrate the same as 0.1 N sodium hydroxide, which is 0.1 M sodium hydroxide or 4 $\frac{\text{g}}{\text{L}}$ sodium hydroxide, and thus we need to prepare 4 $\frac{\text{g}}{\text{L}}$ sodium hydroxide to have a solution that will titrate identically to 14.3 $\frac{\text{g}}{\text{L}}$ sodium carbonate decahydrate.

Common Substitutions

To simplify future calculations, we have prepared general conversions for the most common chemicals used in volumetric analysis. Remember to check all final solutions with relative standardization to ensure that they indeed give the correct results.

Required Chemical	Low Cost Alternative	Substitution Method	Molarity Example	Concentration Example
Hydrochloric Acid	Sulfuric Acid (Battery Acid)	If you are required to prepare an X molarity solution of HCl, prepare a $X \times 0.5$ molarity solution of battery acid	The instructions call for 0.12 M HCl. Instead, prepare 0.06 M sulfuric acid	
Ethanoic (Acetic) Acid	Sulfuric Acid (Battery Acid)	If you are required to prepare an M molarity solution of ethanoic acid, prepare a $M \times 0.5$ molarity solution of sulfuric acid	The instructions call for 0.10 M ethanoic acid. Prepare 0.05 M sulfuric acid.	
Ethandioic (Oxalic) Acid dihydrate ($C_2H_2O_4 \cdot 2H_2O$)	Sulfuric Acid (Battery Acid)	If you are required to prepare an M molarity solution of ethandioic acid, prepare an M molarity solution of sulfuric acid. If you are required to prepare a C concentration solution of ethandioic acid, prepare a $C /_{126}$ molarity solution of sulfuric acid.	The instructions call for 0.075 M ethandioic acid. Prepare 0.075 M sulfuric acid.	The instructions call for 6.3 g/L ethandioic acid. Prepare 0.05 M sulfuric acid.
Potassium Hydroxide	Sodium Hydroxide (Cautetic Soda)	For M molarity potassium hydroxide, make M molarity sodium hydroxide. For C concentration potassium hydroxide, make $C \times^{40}/_{56}$ concentration sodium hydroxide.	The instructions call for 0.1 M potassium hydroxide. Just prepare 0.1 M sodium hydroxide.	The instructions call for 2.8 g/L potassium hydroxide. Prepare 2 g/L sodium hydroxide.
Anhydrous Sodium Carbonate	Sodium Carbonate Decahydrate (Soda Ash)	For M molarity anhydrous sodium carbonate, make M molarity sodium carbonate decahydrate. For C concentration anhydrous sodium carbonate, make $C \times^{286}/_{106}$ sodium carbonate decahydrate.	The instructions call for 0.09 M anhydrous sodium carbonate. Make 0.09 M sodium carbonate decahydrate.	The instructions call for 5.3 g/L anhydrous sodium carbonate. Make 14.3 g/L sodium carbonate decahydrate.
Anhydrous Sodium Carbonate	Sodium Hydroxide (caustic soda)	For M molarity anhydrous sodium carbonate, make $M \times 2$ molarity sodium hydroxide. For C concentration anhydrous sodium carbonate, make $C \times 2 \times^{40}/_{106}$ sodium hydroxide.	The instructions call for 0.09 M anhydrous sodium carbonate. Make 0.18 M sodium hydroxide.	The instructions call for 5.3 g/L anhydrous sodium carbonate. 4.0 g/L sodium hydroxide.
Sodium Carbonate Decahydrate ($Na_2CO_3 \cdot 10H_2O$)	sodium hydroxide (caustic soda)	For M molarity sodium carbonate decahydrate, make $M \times 2$ molarity sodium hydroxide. For C concentration sodium carbonate decahydrate, make $C \times 2 \times^{40}/_{286}$ sodium hydroxide.	The instructions call for 0.09 M sodium carbonate decahydrate. Make 0.18 M sodium hydroxide.	The instructions call for 14.3 g/L sodium carbonate decahydrate. Make 4.0 g/L sodium hydroxide.
Anhydrous Potassium Carbonate	Sodium Carbonate decahydrate (Soda Ash)	For M molarity potassium carbonate, make M molarity sodium carbonate decahydrate. For C concentration potassium carbonate, make $C \times^{286}/_{122}$ concentration sodium carbonate.	The instructions call for 0.08 M anhydrous potassium carbonate. Prepare 0.08 M sodium carbonate decahydrate.	The instructions call for 6.1 g/L anhydrous potassium carbonate. Prepare 14.3 g/L sodium carbonate decahydrate.
Anhydrous Potassium Carbonate	Sodium Hydroxide (caustic soda)	For M molarity potassium carbonate, make $M \times 2$ molarity sodium hydroxide. For C concentration potassium carbonate, make $C \times 2 \times^{40}/_{122}$ concentration sodium hydroxide.	The instructions call for 0.08 M anhydrous potassium carbonate. Prepare 0.16 M sodium hydroxide.	The instructions call for 6.1 g/L anhydrous potassium carbonate. Prepare 4.0 g/L sodium hydroxide.

Additional Notes

- In volumetric analysis experiments with two indicators, it is not possible to substitute one chemical for another as the acid/base dissociation constant is critical and specific for each chemical. It is still possible to substitute sodium carbonate decahydrate for anhydrous sodium carbonate with the above conversion.
- These substitutions only work for volumetric analysis. In qualitative analysis, the nature of the chemical matters. If the instructions call for sodium carbonate, you cannot provide sodium hydroxide and expect the students to get the right answer!

21.1.3 Properties of Indicators

Acid-base Indicators

These indicators are chemicals that change colors in a specific pH range, which makes them suited to use in acid-base reactions. When the pH of changes from low pH to high pH or from high to low, the color of the solution changes. Four common acid-base indicators are methyl orange (MO), phenolphthalein (POP), bromothymol blue (BB), and universal indicator (U)

- Methyl Orange, MO, is always used when titrating a strong acid against a weak base. The pH range of MO is 4.0-6.0 and thus no color change is observed until the base is completely neutralized. If you use MO with a weak acid, the color might start to change before completely neutralizing the acid.
- Phenolphthalein, POP, is always used when titrating a weak acid against a strong base. The pH range of POP is 8.3-10.0, and thus no color change is observed until the weak acid is completely neutralized. If you use POP with a weak base, the color might start to change before completely neutralizing the base.
- Bromothymol Blue, BB, is used in the same manner as methyl orange.
- Universal indicator, U, is not suitable for volumetric analysis involving either weak acids or bases as it changes color continuously rather than in a limited pH range. It is very useful for tracking the pH continuously over a titration, perhaps by performing two titrations side by side, one with a standard indicator and another with universal indicator.

Any indicator can be used when titrating a strong acid against a strong base. Universal indicator, however, will not produce very accurate results. No indicator is suitable for titrating a weak acid against a weak base. In some experiments, more than one indicator may be used in the same flask, for example when titrating a mixture of strong and weak acids or bases.

Colors of Indicators The colors of the above indicators in acid and base are:

Indicator	Acid	Neutral	Base
Methyl Orange	Red	Orange	Yellow
Phenolphthalein	Colorless	Colorless	Pink
Bromothymol Blue	Yellow	Blue	Blue
Universal Indicator	Red, Orange, Yellow	Yellow/Green	Green, Blue, Indigo

Titration is finished when the indicator starts a permanent color change. For example, when methyl orange turns orange, the titration is finished. If students wait until methyl orange turns pink (or yellow) they have overshot the endpoint of the titration, and their volume will be incorrect. Likewise, POP indicates that the titration is finished when it turns light pink. If students wait until they have an intensely pink solution, they will use too much base and get the wrong answer.

Note that light pink POP solutions may turn colorless if left for a few minutes. This is due to carbon dioxide in the air reacting to neutralize bases in solution.

Note on technique Students should use as little acid-base indicator as possible. This is because some acid or base is required to react with the indicator so that it changes color. If a lot of indicator is used, students will add more acid or base than they need.

Other Indicators

Starch indicator is used in oxidation-reduction titrations involving iodine. This is because iodine forms an intense blue to black colored complex in the presence of starch. Thus starch allows a very sensitive assessment of the presence of iodine in a solution.

It is important to add the starch indicator close to the end point when there is an acid present. The acid will cleave the starch and that will prevent the starch from working properly. Students using starch should use a pilot run to get an idea when to add the starch indicator.

Preparation of Indicators

- Methyl orange (MO): if you have a balance, weigh out about 1 g of methyl orange powder and dissolve it in about 1 L of water. Store the solution in a plastic water bottle with a screw on cap and it will keep for years. If it gets thick and cloudy, add a bit more water and shake. If you do not have a balance, add half of a small tea spoon to a liter of water.
- Phenolphthalein (POP) Dissolve about 0.2 g of phenolphthalein powder in 100 mL of pure ethanol; then add 100 mL water with constant stirring. If you use much more water than ethanol, solid phenolphthalein will precipitate. Store POP in a plastic water bottle with a screw on cap. We recommend making POP in smaller quantities than MO as it does not keep as well, mostly due to the evaporation of ethanol. If the solution develops a precipitate, add a bit of ethanol and shake. We do not recommend using purple methylated spirits as a source of ethanol for making POP. You can distill purple spirits to make clear spirits. For clear methylated spirits, use 140ml of spirit and 60ml of water, as spirits generally are already 30% water.
- Starch: place about 1 g of starch in 10 mL of water in a test tube. Mix well. Pour this suspension into 100 mL of boiling water and continue to boil for one minute or so. Alternatively, use the water leftover after boiling pasta or potatoes. If this is too concentrated, dilute it with regular water.
- The authors have never prepared bromothymol blue or universal indicator from powder, but suspect their preparation is similar to methyl orange.

Note that the exact mass of indicator used is not very important. You just need to use enough so that the color is clearly visible. Students use very little indicator in each titration, and a liter of indicator solution should last you a long time.

21.1.4 Traditional Volumetric Analysis Technique

The Volumetric Analysis practical consists of an acid that is being titrated acid against a base until neutralization, in order to determine the concentration of the base. On NECTA practical exams, titrations are done four times: a pilot followed by three trials. The pilot is done quickly and is used to determine the approximate volume needed for neutralization to speed up the following trials.

Example: If the pilot gives an end point of 25.00 mL, then for the three subsequent trials, 20.00 mL can quickly be added from the burette. Then begin to add solution slowly until the endpoint is reached.

Results from the pilot are not accurate and are not included when doing calculations. Students should also know that not all three trials are always used in calculating the average volume used. Values of trials must be consistent and within $\pm 0.2 \text{ cm}^3$ of each other to be valid for average volume determination.

Volumetric Analysis Without Using Burettes

Use plastic syringes instead of burettes. As of late 2010, the most precise syringes available are the 10 mL NeoJect brand - you should use these (A titration with 2 plastic syringes is more accurate than a titration with a burette and a cheap glass pipette). If use of these syringes is new to you, read [Use of a Plastic Syringe to Measure Volume](#) (p. 45) before continuing.

If students are using syringes in place of burettes, they require two syringes for the practical: one to use as a burette (for acid) and one to use as a pipette to transfer base into the flask. It may be useful to label the different syringes "burette" / "flask" or "acid" / "base".

Preparation (without burettes)

1. Clean the “pipette” syringe with water.
2. Rinse the “pipette” syringe with base solution that will be put into the flask.
3. Use the “pipette” syringe to transfer base into the flask. To do this accurately, first add 1 mL of air to the syringe and then suck up the base beyond the desired amount. Push back the plunger until the top of the fluid is at the required volume.
4. Record the total volume transferred (multiple transfers with the 1 syringe may be required to react the desired volume).
5. If you are using indicator, add a few drops to the flask.
6. Clean the “burette” syringe with water.
7. Rinse the “burette” syringe with the acid solution that will be used for titration.

Procedure (without burettes)

1. Add 1 mL of air to the syringe and suck up the acid beyond the 10 mL mark. Slowly push back the plunger until the top of the fluid is exactly at the 10 mL line.
2. Slowly add acid from the “burette” syringe into the flask. Swirl the flask as you titrate. Be careful. Make sure the acid lands in the base, avoid acid drops landing on the sides of the flask.
3. Stop titration when the slight color change become permanent. This is the end point.
4. Often, more than 10 mL of acid will need to be used. This is not a problem. Once 10 mL is finished in the syringe, students should just fill it up again and continue the titration.
5. Record final volume of acid transferred by the “burette” syringe.

Notes for when using syringes in place of burettes

- Students must record their results in a manner that is consistent with traditional reporting.
- On rough paper, students should calculate the volume of solutions used during titration. If they only used one syringe and the initial volume in the syringe was 10.00 mL and the final volume was 2.55 mL, the student used 7.45 mL of solution. If they used two full syringes and then part of a third (which had the initial reading of 10.00 mL and a final reading of 4.65 mL), the student used $5.35 \text{ mL} + 10.00 \text{ mL} + 10.00 \text{ mL} = 25.35 \text{ mL}$ total.
- In the table of results, the student should write 25.35 mL for Volume Used. If they had used a burette, the initial reading would have been 0.00 mL and the final reading would have been 25.35 mL. This is what they should write in their table of results.
- When using a syringe as a burette, students should write 0.00 mL as the Initial Volume and then, for the Final Volume, they should write the number they calculated for the total volume used.

21.2 Qualitative Analysis

21.2.1 Overview of Qualitative Analysis

The salts requiring identification have one cation and one anion. Generally, these are identified separately although often knowing one helps interpret the results of tests for the other. For ordinary level in Tanzania, students are confronted with binary salts made from the following ions:

- Cations: NH_4^+ , Ca^{2+} , Fe^{2+} , Fe^{3+} , Cu^{2+} , Zn^{2+} , Pb^{2+} , Na^+
- Anions: CO_3^{2-} , HCO_3^- , NO_3^- , SO_4^{2-} , Cl^-

At present, ordinary level students receive only one salt at a time. The teacher may also make use of qualitative analysis to identify unlabeled salts.

21.2.2 The steps of Qualitative Analysis

The ions are identified by following a series of ten steps, divided into three stages. These are:

- Preliminary tests: These tests use the solid salt. They are: appearance, action of heat, action of dilute H_2SO_4 , action of concentrated H_2SO_4 , flame test, and solubility.
- Tests in solution: The compound should be dissolved in water before carrying out these tests. If it is not soluble in water, use dilute acid (ideally HNO_3) to dissolve the compound. The tests in solution involve addition of NaOH and NH_3 .
- Confirmatory tests: These tests confirm the conclusions students draw from the previous steps. By the time your students start the confirmatory tests, they should have a good idea which cation and which anion are present. Have students do one confirmatory test for the cation they believe is present, and one for the anion you believe is present. Even if several confirmatory tests are listed, students only need to do one. When identifying an unlabelled container, however, you might be moved to try several, especially if you are new to this process.

21.2.3 Local Materials in Qualitative Analysis

For all low-cost local material substitutes, consult the section on [Local Materials List](#) (p. 131).

- **Heat Source:** Motopoa burners cost nothing to make (soda bottle caps) and consume only a small amount of fuel. They give a non-luminous flame ideal for flame tests and still produce enough heat for the other tests.
- **Test Tubes:** Plastic test tubes suffice.
- Litmus paper: Rosella flowers give very good results.
- Low-cost sources of chemicals (see *Shika Express Chemistry* companion manual).

Share expensive chemicals among many schools. A single container of potassium ferrocyanide, for example, can supply ten or even twenty schools for several years. Schools should consider bartering 10 g of one chemical for 10 g of another. Another alternative is for all of the schools in a district or town to pool money to buy one container of each required imported reagent, and then divide the chemicals evenly.

Part V

Hands-On Activities

Chemistry Activities for Form I

22.1 Introduction to Chemistry

Chemistry plays a very important role in our daily life. Many processes at home, particularly in the kitchen, are chemical processes we rarely spend a day without using products from parts of the chemical industry such as the pharmaceutical industry, the food industry, the paper industry and the petroleum industry to name a few.

During an introduction to chemistry students should be shown where their lives and the products they use link in with the chemical industry. Students' own experience of chemistry comes from their daily lives and not from working in a laboratory. A student's environment is their chemistry lab!

22.1.1 Chemical Products

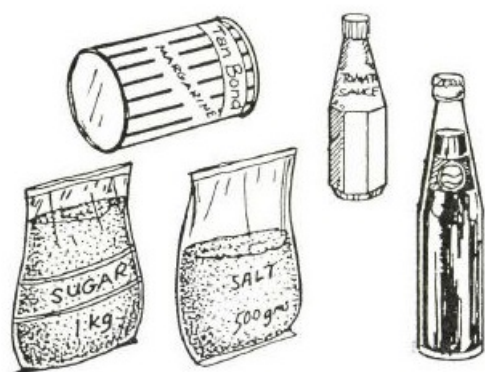

22.1.2 Pollution and Chemistry

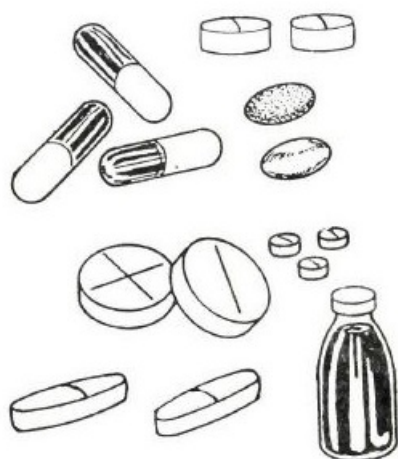

Procedure: In order to demonstrate the importance of chemistry in daily life, ask the students to display and label things produced by chemists. Ask them to arrange similar products together.

Procedure: In order to build up an awareness of pollution in our environment, let the students describe some situations where pollution of air, water and soil happen.

Questions: What can be done to reduce these forms of pollution?

22.1.3 Making an Excursion



Procedure: It can be stimulating to make an excursion around the school ground, to find out where chemical processes can be observed. There can be natural ones like the decomposition of organic substances, cooking, alcoholic drink production, etc.

22.1.4 Posters of Chemical Products

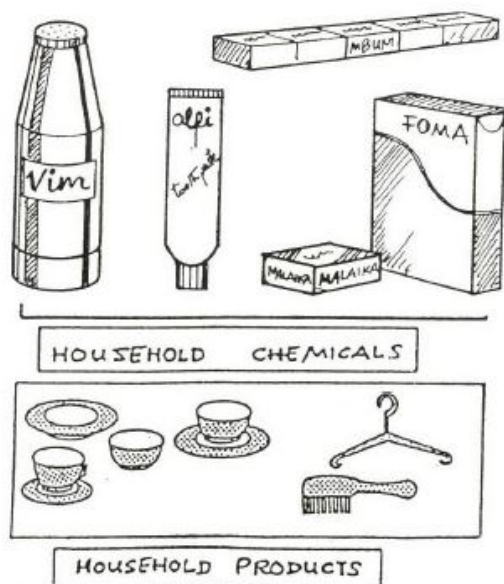

Materials: Manila paper, marker pens, newspapers, scissors

Procedure: Instead of displaying real products, posters can be made in groups with pictures cut out from newspapers. For language training let the pupils talk about their work and what the posters show.

22.1.5 We Are All Chemists



Procedure: Students should understand that we are all chemists and not only those people working in a chemical lab. Let them try out examples of chemical processes with locally available materials.

- Carefully burn some paper, wood, fuel or ignite a matchstick.
- Add some lemon juice to a cup of tea and observe the colour change.
- Let a glass of milk go sour.
- Rub some red or pink petals from flowers on wet soap firmly and observe the change of the colour.
- Try to find some more examples.

22.2 Laboratory Techniques and Safety

22.2.1 Display of Hazardous Chemicals



Procedure: Display some well labelled containers with hazard symbols for the students and let them talk about them.

22.2.2 A Safety Game



Materials: Cards of hazard symbols

Procedure: Play a game with the symbol charts. A student is given a hazard symbol. He has to explain the hazard shown and to explain the necessary safety precautions in order to avoid that hazard.

22.2.3 The Cleanliness Play



Procedure: Ask the students to play group-wise short and funny scenes using appropriate words to make them familiar with cleanliness rules.

22.2.4 The Tidiness Play



Procedure: Chemists are very tidy. Apparatus and reagents should be arranged on the table so that they can be reached easily but at a safe distance from the experiment.

22.3 Heat Sources and Flames

Heat Sources

Materials: Candle, bottle cap, kerosene burner, tin cans, wire, charcoal, glass jar, metal tubes

Procedure: Construct the simple heat sources shown below.

Questions: What are the advantages and disadvantages of each?

22.3.1 Candle Burner



22.3.2 Kerosene Burner



22.3.3 Spirit Burner

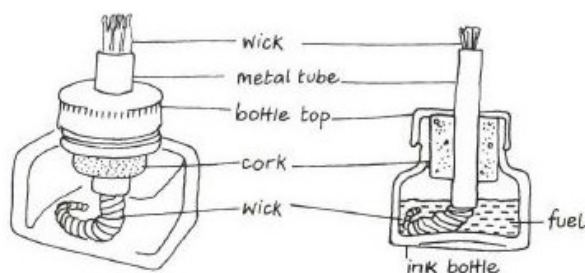

22.3.4 Charcoal Burner

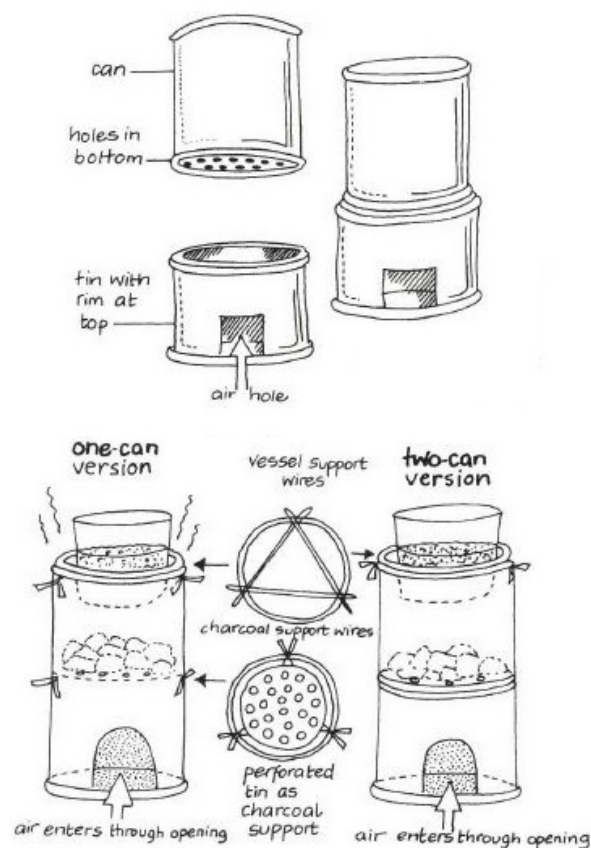

22.3.5 Types of Flames

Materials: Kerosene burner, candle, methylated spirit, kerosene, motopoa, bottle caps, matches, spoon, paper, metal jar lid

Procedure: Light a kerosene burner and observe the flame, adjusting the height of the wicks. Light small amounts of methylated spirit and motopoa in separate bottle caps. Light the candle and observe the flame. Light the paper on a metal lid and observe the flame. For each test, hold a metal spoon over the flame and examine for soot.

Observations: Kerosene produces a luminous flame. A long wick gives a bigger and brighter flame with more soot. Spirit and motopoa produce non-luminous flames and does not produce soot. Candles and burning paper produce a luminous flame and deposit soot on the spoon.

22.4 The Scientific Procedure

22.4.1 Acids and Bases



Acids or Bases?

Materials: Bottles, bottle caps, water, vinegar, lemons, baking soda, soda, soap, antacid tablets, rosella leaves, straws/syringes

Setup: Prepare solutions for each of the items above in separate bottles. Prepare indicator by placing rosella leaves in hot water.

Problem: What differences can we observe among acids and bases?

Solutions	Hypothesis (Which is different?)	Experimental Result
Vinegar, lemon, baking soda		
Vinegar, baking soda, soap		
Baking soda, antacid, soda		
Soda, soap, vinegar		

Hypothesis: For each set of solutions, which one will reveal a colour different from the others? Record your predictions in the table.

Procedure: Place small amounts of 3 different solutions in separate bottle caps according to the table. Add a few drops of rosella indicator to each.

Observations: Record observations of colour change under *Experimental Result* in the table.

Questions:

1. Which solutions have similar properties?
2. Which solutions are acids? What colour do they show?
3. Which solutions are bases? What colour do they show?

Theory: Coloured leaves such as rosella act as indicators for identifying acids and bases. Adding rosella indicator reveals a red colour for acids and a blue colour for bases. Students do not need to understand the differences between acids and bases in order to observe their different behaviours. Locally available examples of acids include sour milk, citrus fruits and soda. Local bases include ammonia, toothpaste and detergent.

22.4.2 Mixing Acids and Bases

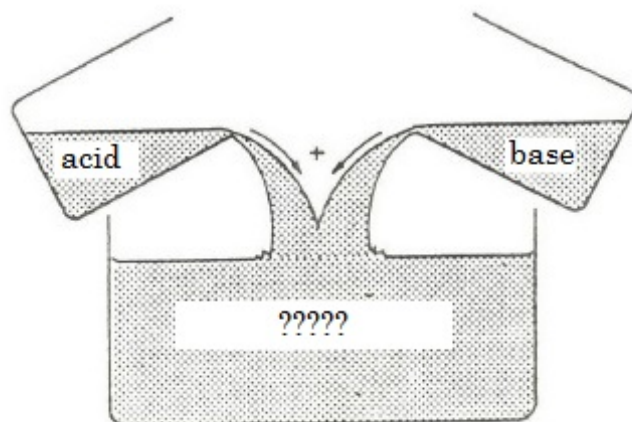

Problem: What happens when acids and bases are mixed together?

Solutions to Mix	Hypothesis (What colour?)	Experimental Result
Mix vinegar and lemon		
Mix baking soda and soap		
Mix vinegar and baking soda		

Hypothesis: Predict any colour changes or observations when pairs of solutions are mixed together. Record in the table.

Procedure: Mix small amounts of solutions together according to the table.

Observations: Record observations (colour changes, etc.) in the table.

Questions:

1. What happens when an acid is mixed with an acid?
2. What happens when a base is mixed with a base?
3. What happens when an acid is mixed with a base?

Theory: Mixing acids with acids and bases with bases may cause the colour of the solution to turn darker or lighter depending on the solutions used. Mixing an acid with a base should reveal a colourless solution and produce carbon dioxide gas. You may need to vary the amounts of acid and base to get a colourless solution depending on their concentrations.

22.5 Matter

Concept of Matter

22.5.1 Air is Matter

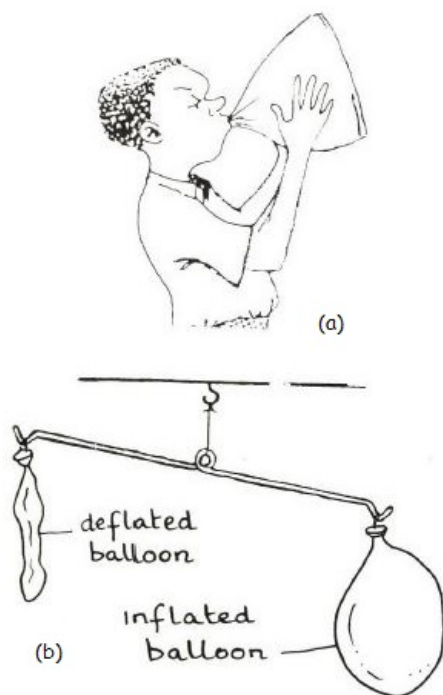

Procedure: Blow a bag or balloon up with air (a). Hang a deflated bag and an inflated bag on either side of a simple wire balance.

Observations: Air in the bag occupies space. The air has mass as indicated by the balance.

22.5.2 Liquid is Matter



Theory: Liquids contain mass, occupy space and can provide a great force under pressure. Don't be like the plumber in the picture!

States of Matter

22.5.3 Students as Matter



Procedure: Use students to demonstrate the concept of states of matter.

Theory: When students or objects are close together, they represent particles in the *solid* state. As they move apart and past each other they represent particles in the *liquid* state. Fast and randomly moving pupils or objects represent particles in the *gaseous* state.

22.5.4 Arranging States of Matter

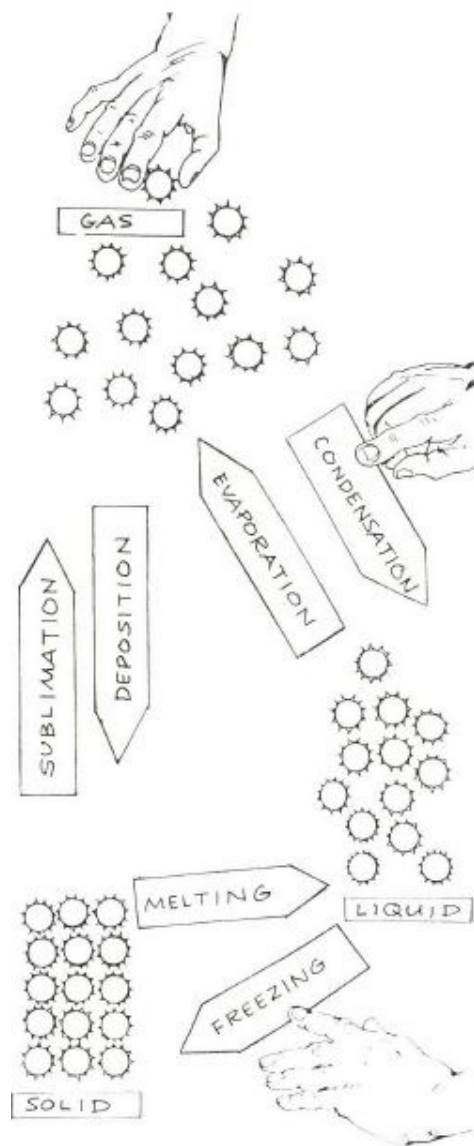

Materials: Bottle caps, paper

Procedure: Have students arrange bottle caps to represent the different states of matter, using labels from paper or cardboard.

Theory: The spacing of the bottle caps represents the distance between particles in each state. Particles have large spaces between them in gases, less space in liquids, and are very condensed in solids.

22.5.5 A Model of Motion

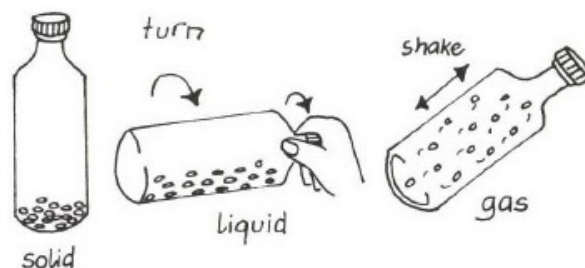

Procedure: Put some dry beans, rice or stones in a clear bottle. Hold the bottle still, then turn it, then shake it vigorously.

Questions: Which activity corresponds to which state of matter?

Theory: The movement of particles in solids is small and hence they are in fixed order. In liquids the particles move past each other and have lost the stiff order. In gases they move very fast and randomly, losing all order.

Physical and Chemical Changes

22.5.6 Physical or Chemical?

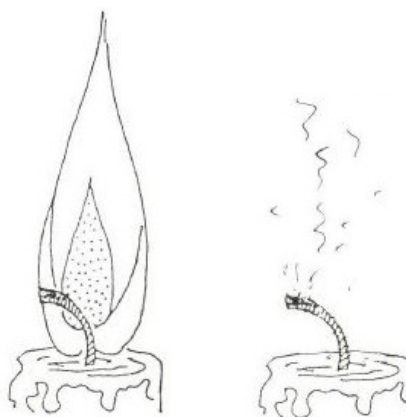

Materials: Candle, paper, sugar, bottle caps

Procedure: Light a candle and let it drip into a bottle cap. Then light the paper and catch the remains in another cap. Finally place a small amount of sugar in a cap and heat it over the flame.

Observations: The candle wax melts into a liquid, then upon cooling reforms into a solid. The paper burns up and leaves ash. The sugar turns brown upon heating, leaving a brownish black solid upon cooling.

Theory: The candle wax undergoes a physical change that only affects its physical properties. After heating, we can get the original wax back again by cooling. The paper and sugar undergo chemical changes since the change is not reversible.

22.5.7 Physical and Chemical Changes of Metals

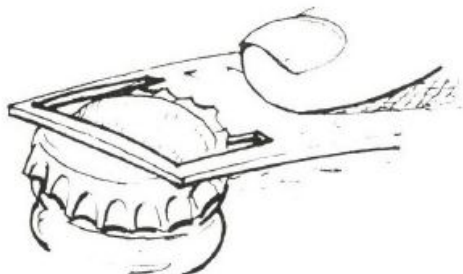

Materials: Soda bottle, various metals, [Heat Source](#)

Procedure: Physical and chemical changes can be demonstrated with iron wool, copper, aluminium or lead.

(a) Apply physical forces.

(b) Heat the metals in a strong flame (blow pipe flame). Allow the metals to cool.

Theory: If only the form has changed, these are physical changes. If colour, density etc. have changed permanently, these are chemical changes.

Elements and Symbols

22.5.8 Element Memory Game

Materials: Manila paper/card/paper

Setup: Cut out 2 sets of identical small squares of card or paper. On the first set write the names of some elements and on the second set write their corresponding symbols. Make about 10-15 pairs.

Procedure: Mix the cards together and spread them out on a table face down. Students take turns flipping over 2 cards at a time. If the element and symbol match, they get to keep the cards. If not, they must turn them back over. The player with the most pairs of cards at the end wins!

Compounds and Mixtures

22.5.9 Introducing Mixtures



Procedure: Why not introduce mixtures with a game? Students will like a more concrete introduction. Try it!

22.5.10 Mixtures and Compounds

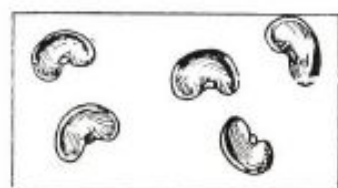

An element

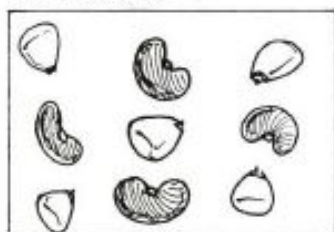

Mixture of elements (eg. Fe+S)



Forming a compound

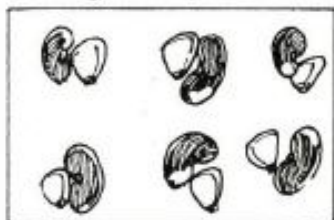

A compound

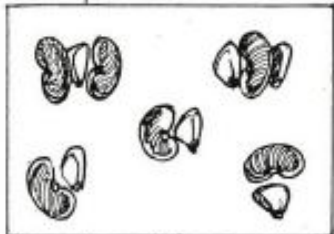

A mixture of compounds

Materials: Beans, seeds, corn kernels, etc.

Procedure: Use the items to represent various elements, mixtures and compounds as shown.

Theory: In homogeneous mixtures, the particles are uniformly mixed and it is impossible to see the different ingredients even by using a light microscope. For example, solutions and the mixture of gases in air are homogeneous mixtures.

In heterogeneous mixtures, the particles are also uniformly mixed. But the individual components can be seen either by eye or by using a magnifying glass or microscope.

22.5.11 Student Compounds

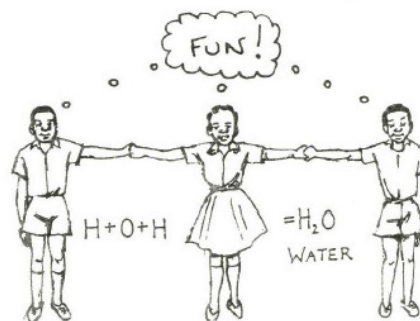
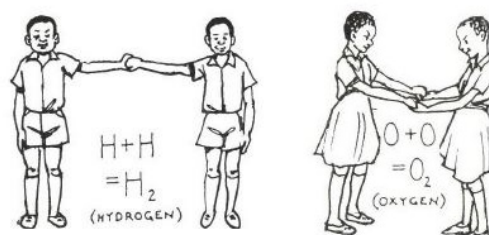

Procedure: To show that elements combine in constant proportions, ask the students to play a game of forming molecules like those of water, ammonia, methane, ethane, carbon dioxide etc. See the figures.

22.5.12 Homogeneous Mixtures

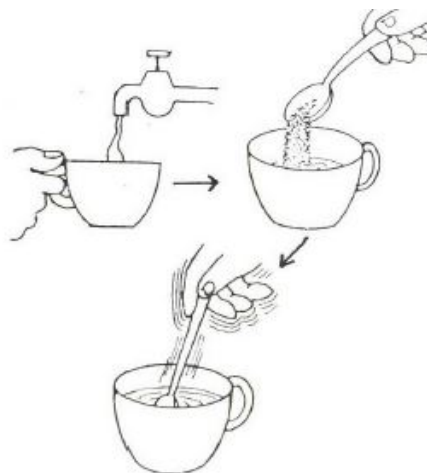

Materials: Salt, water, spoon, bottle

Procedure: Dissolve some table salt or sugar in drinking water to demonstrate a solution as a homogeneous mixture. Ask the pupils to taste the solution to prove that the chemical properties of the solute have not changed.

Hazards: Ensure that clean water, cups and spoons are used.

22.5.13 Heterogeneous Mixtures

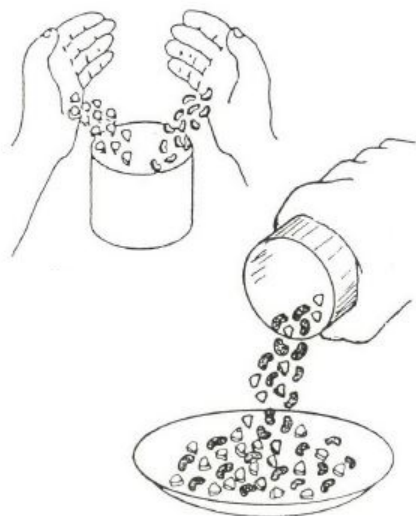

Materials: Bean seeds, maize grains, salt, sand, sugar

Procedure: (a) Take a handful of maize grains and another handful of bean seeds. Each handful is like a pure substance having only one kind of particle. Now mix the maize grains and the beans in a container. Repeat with sand and salt or sand and sugar.

Theory: This is like a heterogeneous mixture since different particles can be seen.

Applications: Common everyday examples of heterogeneous mixtures are turbid water and porridge. Preparing concrete is another example which can be observed in daily life.

22.5.14 Separating Iron and Sulphur

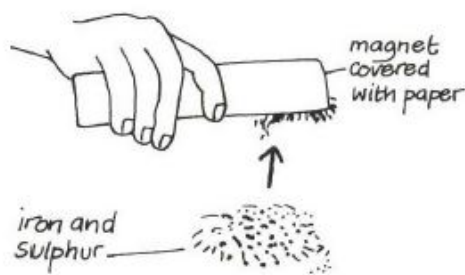

Materials: Steel wool, sulphur powder, magnet, paper

Setup: Prepare a mixture of iron filings and sulphur powder.

Procedure: Cover the magnet with paper. The magnet will attract only the iron, leaving sulphur behind.

Theory: The magnetic properties of the iron filings allow the magnet to separate the mixture by attracting the iron.

22.5.15 Suspensions



Theory: A suspension is a mixture of a solid and a liquid. Suspensions can be made from solids like sand, soil, ash, sawdust etc. with a liquid like water.

Applications: Let the students find more examples from their daily life (e.g. toothpaste and porridge).

22.5.16 Emulsions



Materials: Kerosene/oil, water, bottle, soap

Theory: Emulsions are made from two immiscible liquids like kerosene or oil in water. Shake and let it stand for some time to demonstrate an unstable emulsion. If soap is added to the water it acts as an emulsifier and stabilizes the emulsion. Wood ash also acts in this way.

Applications: Let the students find more examples in daily life (e.g. milk).

22.5.17 Miscible and Immiscible Liquids

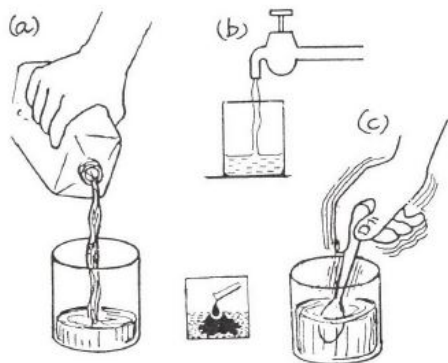

Materials: Water, kerosene, alcohol, bottles

Procedure: Mix equal amounts of water separately with kerosene and alcohol in two different containers.

Hazards: Kerosene is water polluting! Do not pour it into the sink. Keep it in a labeled container for further experiments.

Theory: The water and kerosene combine to make an immiscible liquid, whereas the water and alcohol form a miscible liquid.

22.5.18 Lava Lamp

Materials: Bottle, water, food coloring, oil, effervescent antacid tablets, ashlight,

Procedure: Fill the bottom 10 cm of a water bottle with water. Add a few drops of food coloring. Fill rest of the bottle with oil. Drop in an effervescent antacid tablet. Cap and put a flashlight underneath the bottle.

Observations: Observe the colors and the movement of the liquids.

Theory: Oil is a compound that is hydrophobic (it repels water). Oil is a long non-polar hydrocarbon, while water is a small polar compound. This means that the water cannot mix with the oil layer. This is why there are two layers on mixing oil and water. Adding the effervescent antacid tablets dissolve and release carbon dioxide in the water layer. The carbon dioxide dissolves in the water and forms small bubbles of carbon dioxide. These bubbles trap small amounts of food coloring. These bubbles rise since they have a much lower density than water. When the bubble reaches the surface, the carbon dioxide escapes and the colored water bubble falls down through the oil layer.

22.5.19 Moving Colours

Materials: Milk, various food colouring, powdered soap, cotton ball or swab, shallow dish or plate

Procedure: Pour in just enough milk to cover the plate or the bowl. Place a few drops of food colouring around the plate of milk. Soak the cotton swab in some soapy water and touch it to the center of the milk plate.

Observations: The colours will start to move and swirl towards the center.

Theory: Milk is made up of fats and different proteins (non-polar molecules). The water solution in the food colour and the non polar milk barely mix. Soap is a compound that is both polar on one end and non polar on the other end. The milk and the soap intermingle forming micelles. In addition, the surface tension of the water in the milk breaks, allowing food colouring to move around in the milk.

Separating Mixtures

22.5.20 Decantation

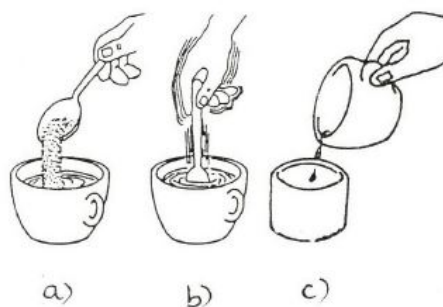

Materials: Cup, water, sand

Procedure: This procedure is based on the different density of particles. Shake some sand with water, let it stand for some time and decant the water.

Applications: Maize seeds are usually washed before milling. After washing the maize seeds are separated from the water by decantation.

22.5.21 Evaporation

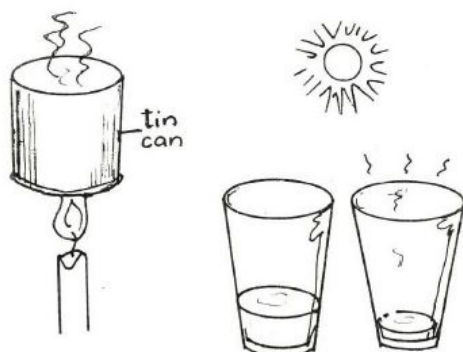

Materials: Container, salt, water

Procedure: This procedure is based on different boiling points. (a) Dissolve some common salt in water and heat to dryness. (b) Better crystals can be obtained by evaporating most of the water. The remaining water can be evaporated slowly in the sun.

22.5.22 Distillation

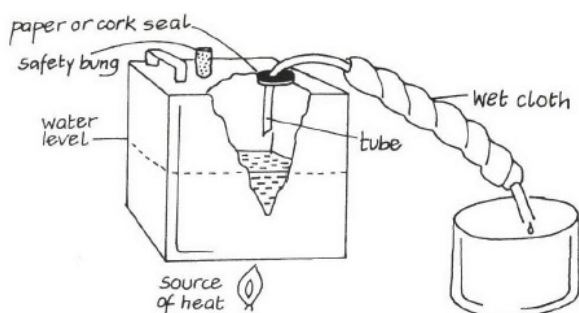

Materials: Metal can, cork/rubber stopper, plastic tubing, wet cloth, container, Heat Source

Procedure: Fill a container half way with water. Cut a hole in the top and fix a rubber stopper with a plastic tube through the center. Wrap a wet cloth around the tube and feed it into a can. Add a safety bung using rubber or cork to prevent against very high pressures within the container and place the container over the heat source.

Hazards: Make sure the safety bung is not too tight and that the container always has water inside.

Theory: Heating the can produces steam which is then cooled by the wet cloth. Steam condenses to produce water.

Applications: This method can be used to purify water.

22.5.23 Distillation of a Solution

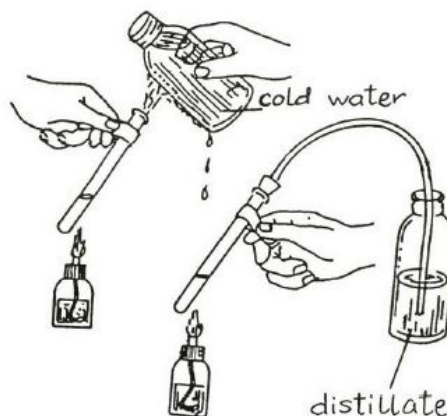

Materials: Candle, bottles, cold water, ash extract, tube

Procedure: Take the ash extract obtained by filtration and distill it as shown. The ash extract is separated into a liquid (distillate) and a solid residue.

Hazards: Take care due to the small diameter of the connection tubes.

Theory: The solids have a much higher boiling point than the water.

22.5.24 Separating Immiscible Liquids

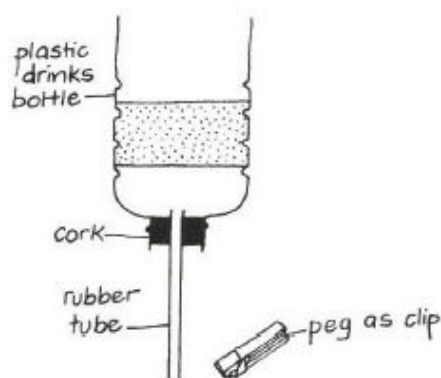

Materials: Kerosene, water, bottle, cork, rubber tube, clothespin

Procedure: Combine 2 liquids together that do not mix well, e.g. groundnut oil and water; palm oil and water; petrol/diesel and water; castor oil and water. Palm oil is particularly effective because it is brightly coloured.

Theory: When 2 liquids will not mix with each other they are said to be immiscible. One liquid will sink below the other and can be drawn off as shown.

22.5.25 Filtration



Theory: Filtration is based on the same principle as sieving. It is a frequently used process in daily life. The students can explain different filtering processes they know.

22.5.26 Chromatography

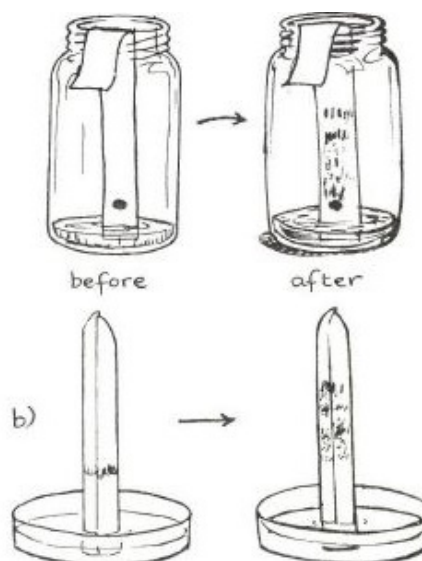

Materials: Pen/marker, newspaper, water, chalk, ink

Procedure: (a) Make a line with ink or a black felt pen (containing water soluble colour) on a strip made from filter paper or the white rim of a newspaper. Hang the strip into water, so that the spot is above the water level.

(b) Stand a piece of chalk in ink. The chalk must stand upright.

Theory: This procedure is based on the different capillary rise of soluble substances in a porous support. Many colours are mixtures. The different colours rise at different speeds and thus separate.

22.6 Air, Combustion, Rusting and Fire Fighting

Composition of Air

22.6.1 What is Air?



Procedure: (a) To show the percentage by volume of the different gases in air take a cardboard box of about 50 cm × 50 cm × 50 cm and partition it using cardboard pieces as shown in diagram (a) according to the following figures: Nitrogen 78%, Oxygen 21%, other 1% (Argon 0.93%, other noble gases 0.002%, carbon dioxide 0.03%, hydrogen 0.001%). (b) The classroom can be imagined to be a box with a certain volume of air and divided accordingly by students as shown.

22.6.2 Gases in Air

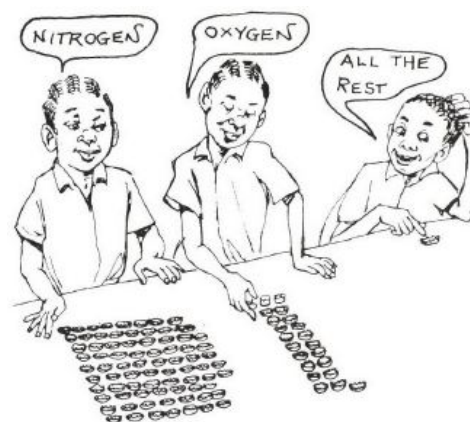

Materials: Bottle tops/stones

Procedure: Collect a hundred bottle tops or stones. Arrange in ten rows of ten. Each bottle top represents one percent (by volume) of the gases in the air. The bottle tops can then be divided according to the percentages described in the previous activity.

Combustion

22.6.3 Requirements for Combustion

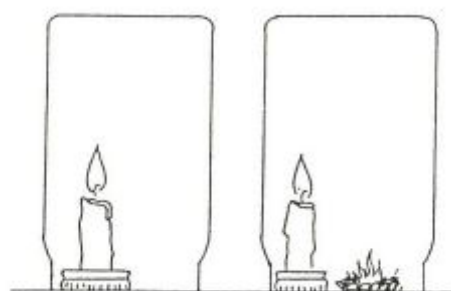

Materials: 2 glass jars, 2 candles, bottle caps, kerosene or spirit

Procedure: Place 1 jar over a lit candle and the other jar over both a candle and a kerosene or spirit flame in a bottle cap.

Questions: Which candle flame goes out first?

Observations: The candle in the jar with the spirit burner goes out first.

Theory: Three elements are necessary for combustion: heat, fuel and oxygen. In the second jar, both the candle and spirit flame are consuming oxygen and so the oxygen gets depleted faster, extinguishing the flame.

22.6.4 Rising Water



Materials: Candle, dish, water, glass

Procedure: Place a candle in a dish fixing it securely with melted wax. Fill the dish with water. Put glasses of different sizes over the candle.

Observations: The water rises to different levels after the flame goes out.

Theory: Once the glass is placed over the candle, the flame consumes the remainder of the oxygen in the glass, replacing it with carbon dioxide and other gases. The heating of the gases causes expansion and bubbles come out of the jar. This is followed by their subsequent cooling and contraction, which reduces the volume of gas inside the glass and allows water to enter.

22.6.5 H₂O as a Product of Combustion

Materials: Glass jar/plastic bottle, water, candle

Procedure: Fill the bottle with water and hold it just above a lit candle, far enough so that it does not burn.

Observations: After a minute or two, condensation forms on the outside of the container, showing that water is a product of combustion.

22.6.6 CO₂ as a Product of Combustion



Materials: Tall glass, wood ash, dilute acid, match, candle

Procedure: Place some wood ash in a tall glass and add some dilute acid. Drop a lit match into the glass and wait for it to stop burning. Now pour the glass over a lit candle.

Observations: Pouring the glass puts out the candle flame.

Theory: The carbon dioxide produced stays in the glass since it is denser than air. Carbon dioxide extinguishes flames since it does not support combustion.

Applications: Fire extinguishers

22.6.7 Burning Money

Materials: Methylated spirits, water, container, matches, paper money, clothespin

Procedure: Make a mixture of 3 parts methylated spirits and 2 parts water. Soak the money in the mixture. Remove with a clothespin and light it with a match. After about 5 seconds drop the money into the extra water.

Observations: The money appears to burn but remains intact.

Theory: The ethanol in the methylated spirit burns at a low temperature while the water protects the bill from combusting. However, if there is a lot of ethanol and it burns for a long time, the water will evaporate away and the bill will start burning.

Firefighting

22.6.9 Making a Fire Extinguisher

22.6.8 Putting Out Fires

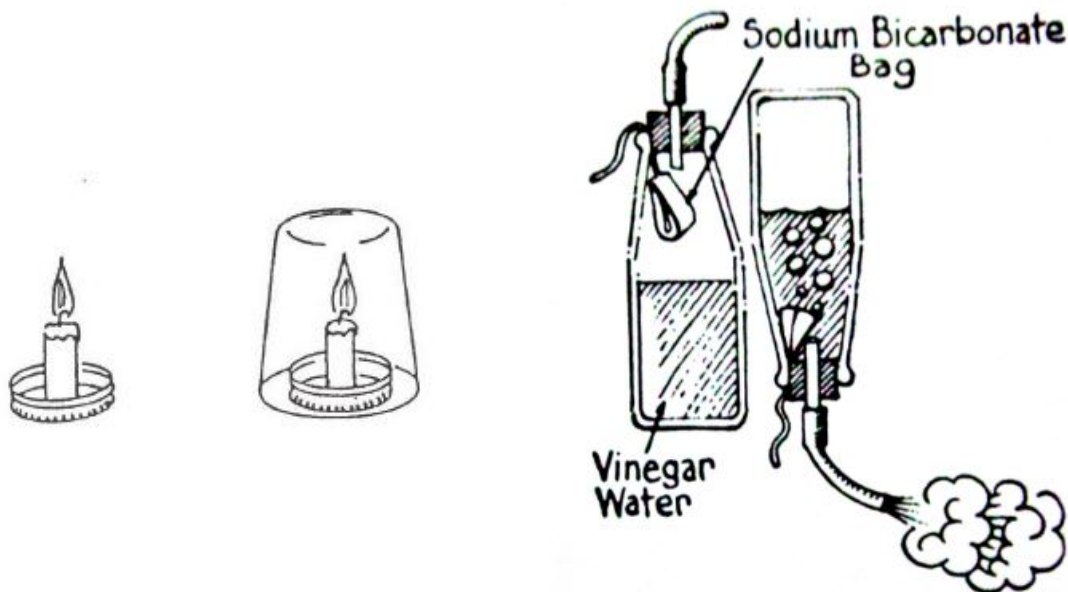

Materials: Bottle caps, ethanol, kerosene, water, matches, sand, glass jar

Procedure: Put a small amount of ethanol into a bottle cap and light it with a match. Pour water onto the flame. Repeat using a handful of sand and then an inverted glass over the flame. Now add a small amount of kerosene to a bottle cap. Repeat the above methods, but add water *carefully* using a syringe near the base of the flame. Repeat the steps for a burning piece of paper.

Hazards: Perform these tests on a laboratory floor, not a wooden table or desk.

Observations: The ethanol and paper flames are extinguished in all 3 cases. However, adding water to the kerosene *does not* extinguish it.

Theory: Overturning a glass jar deprives the flames of oxygen and thus extinguishes them. A kerosene fire can NOT be extinguished by water because water is immiscible with kerosene, and it only causes the fire to spread.

Materials: Bottle, tea bag, bicarbonate of soda, vinegar, water, plastic tube, super glue

Setup: Empty a tea bag and fill it with sodium bicarbonate. Suspend it in a bottle half-filled with a vinegar-water solution. Poke a hole in the cap and insert a plastic tube. Make sure it is sealed using super glue or clay.

Procedure: Invert the bottle and use the tube to direct the spray at a lit candle.

Theory: The reaction produces carbon dioxide gas which extinguishes flames. This is how fire extinguishers eliminate flames.

Rusting

22.6.10 Conditions for Rusting

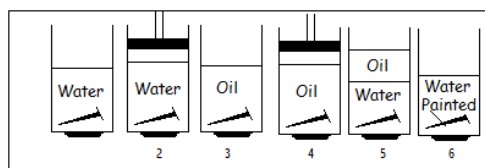

Materials: 6 syringes, 6 nails, water, oil, paint

Setup: Seal the bottoms of the syringes by melting the plastic.

Procedure: Place a nail in each syringe. Paint the final nail. Fill the syringes as shown, closing some of them with their plungers. Observe the nails over time and note which ones show rusting.

Observations: Syringe 1 should show rusting, while the others do not.

Theory: Syringe 1 is the control - both water and oxygen react with the nail. In syringe 2, no oxygen is available. In syringe 3, there is no water and oil makes it difficult for oxygen to reach the nail. In syringe 4, neither water nor oxygen are present. In syringe 5, water is available, but the layer of oil prevents oxygen from reaching it since oxygen does not travel easily through oil. In syringe 6, painting covers the iron surface, so there is no iron to produce rusting.

22.6.11 Rusting of Steel Wool

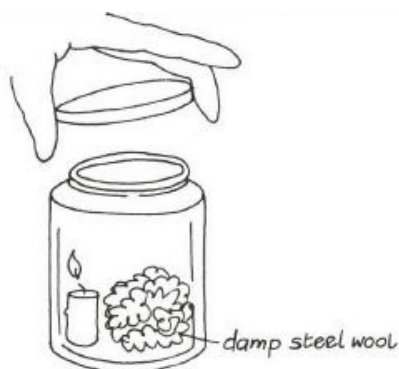

Materials: Steel wool, candle, 2 glass containers

Procedure: Wet the steel wool and place some in each container. Seal one container. Place a lighted candle in the other container. When the candle has burnt for several minutes seal the container with a lid. The candle will go out eventually. Leave both containers for 2 days.

Observations: The steel wool in the container with the candle should not rust as much because oxygen has been removed by the candle.

22.6.12 Rusty Nails

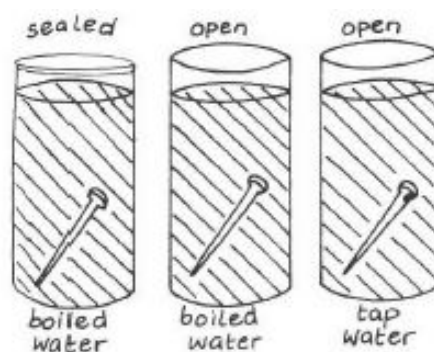

Materials: 3 containers, 2 nails, boiled water, tap water

Procedure: Place a nail in each of the containers and leave for a day.

Observations: The only nail which does not rust is the one in the sealed jar of boiled water.

Theory: Boiling the water removes the oxygen and sealing it prevents oxygen from the air dissolving in it.

22.6.13 Preventing Rusting



Materials: tin can, oil

Procedure: Make 2 large scratches on the surface of a tin can (not an aluminium can often used for drinks). Put a thin layer of oil onto one scratch. Leave the tin exposed to the air for a few days. Note which scratch rusts.

Observations: The scratch not covered in oil rusts, while the other does not.

Theory: Oil prevents water and oxygen from reaching the surface of metal, and so no rusting occurs.

Applications: Machine parts often cannot be protected by painting or other means so they are regularly oiled.

Chemistry Activities for Form II

23.1 Oxygen

Preparation of Oxygen

23.1.1 Using Hydrogen Peroxide

Materials: Dry cell, hydrogen peroxide, water, plastic bottle

Setup: Open a dry cell battery and peel back the metal casing to reveal a black powder. This is Manganese (IV) oxide.

Procedure: Scoop out the powder and place in a plastic bottle. Add about 20 mL of dilute hydrogen peroxide. Crush and cap the bottle.

Hazards: Hydrogen peroxide is corrosive. Be sure to dilute the solution.

Observations: The bottle inflates with oxygen gas.

Theory: Hydrogen peroxide decomposes into water and oxygen rather easily. The manganese (IV) dioxide acts as a catalyst. The chemical equation for this reaction is:

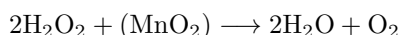

23.1.2 Using A Yeast Catalyst

Materials: Hydrogen peroxide, water, yeast, plastic bottle

Procedure: Place a small amount of dilute hydrogen peroxide in a plastic bottle. Crush the bottle and add some yeast. Cap the bottle and gently invert.

Theory: Yeast contains an enzyme called catalase, which helps to break down hydrogen peroxide into oxygen and water. The enzyme protects the organism by eating the peroxide.

23.1.3 Elephant Toothpaste

Materials: Syringe/measuring cylinder, powdered soap, yeast, hydrogen peroxide, food colour

Procedure: Mix powdered soap and a warm yeast solution in a syringe or large measuring cylinder. Add food colouring if desired. Pour in hydrogen peroxide.

Observations: A large amount of foam/bubbles bursts out of the container.

Theory: Catalase decomposes hydrogen peroxide to form water and oxygen gas. The soap traps the gas in bubbles. These bubbles build up upon each other, slowly forcing them out of the container.

23.1.4 Using Potassium Manganate (VII)



Materials: Potassium manganate (VII), Heat Source, test tube/light bulb

Procedure: Carefully heat potassium manganate (VII) (permanganate) in a test tube or in an opened electric bulb.

Theory: Chemical equation for this reaction:



Properties of Oxygen

23.1.5 Burning in Pure Oxygen

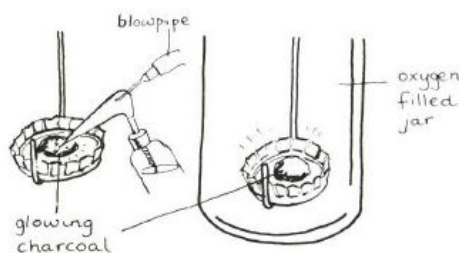

Materials: Charcoal, deflagrating spoon, straw, bottle

Procedure: (a) Ignite charcoal in a deflagrating spoon using a blow pipe. Then put the deflagrating spoon with the burning charcoal into a glass full of pure oxygen.

(b) Bring glowing iron wool into a glass full of pure oxygen.

Observations: Both substances burn with bright flame.

Theory: Charcoal forms carbon dioxide and iron forms iron oxide. Both reactions give out heat (exothermic reactions).

23.2 Hydrogen

23.2.1 Production of Hydrogen

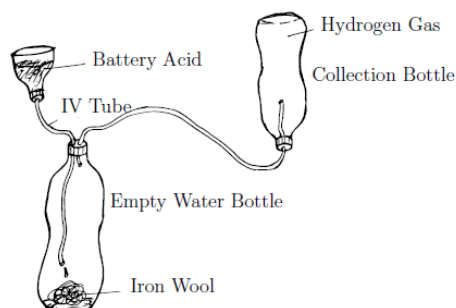

Materials: 2 plastic bottles, funnel, iron wool, plastic tube, battery acid

Setup: Poke 2 small holes in a plastic bottle lid. Run 2 plastic tubes (IV tubes/giving sets) through the holes. Connect one to a funnel (cut off bottle) and the other to an empty upturned bottle as shown.

Procedure: Place some iron wool in the bottom of the first bottle and close the lid. Pour battery acid into the funnel so that it falls on the iron wool.

Hazards: Always wear goggles when handling acids.

Observations: Hydrogen gas collects in the upturned bottle.

23.2.2 Hydrogen 'Pop'

Materials: Plastic bottle, iron wool, citric acid/battery acid/HCl, funnel, balloon, string, matches, paper

Procedure: Place some steel wool in the bottom of a bottle. Slowly pour the acid into the bottle using a funnel. Stretch a balloon over the mouth of the bottle. After it has inflated, tie the balloon closed with a string and remove from the bottle. Light a long stick or piece of paper and hold it underneath the balloon.

Hazards: HCl burns - wear safety goggles when using it. Do not ignite the balloon near the bottle of acid.

Observations: The balloon fills with hydrogen gas. If using citric acid, it may take longer to fill. When the flame is brought near the balloon, it makes a loud 'pop' as it combusts in air.

Notes: You can also use the zinc plate from inside a dry cell in place of iron wool.

23.2.3 Hydrogen Bubbles

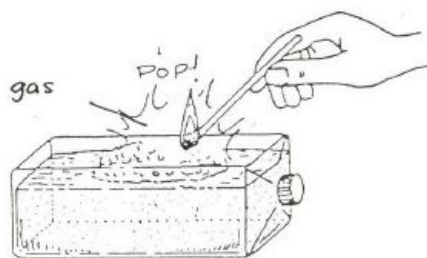
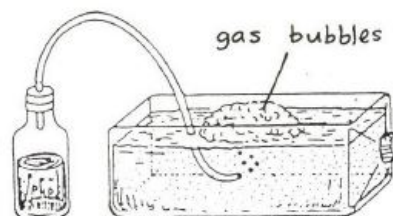

Procedure: Produce hydrogen gas as described above, but run the tube into a water bath. When you begin to see bubbles being produced, bring a long lit stick or burning paper near the bubbles and hear the loud 'pop.'

23.3 Water

Occurrence and Nature of Water

23.3.1 The Water Cycle

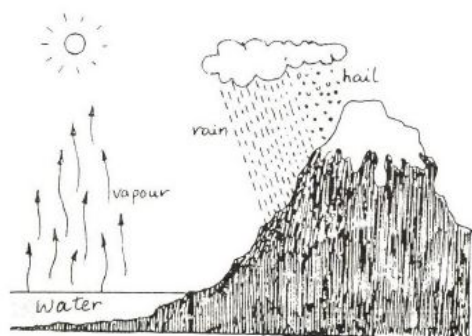

Materials: Cards, scissors

Procedure: Cut out cards and label them according to different terms associated with the water cycle (e.g. evaporation, condensation, precipitation, transpiration, collection). Sketch the picture shown and have students label where each takes place.

23.3.2 Cloud in a Jar

Materials: Wide mouth glass jar, balloon/latex glove, water, matches

Procedure: Add a small amount of water to the jar. Stretch the mouth of the balloon around the mouth of the jar and insert it so it hangs in the bottle. Pull the balloon out and quickly open the seal and drop in a lit match. Quickly reseal, pushing the balloon back inside the bottle, and then pull the balloon outside of the jar again.

Observations: A cloud forms inside the jar.

Theory: By putting the balloon in the jar and pulling it out, the volume inside the container increases and some of the water turns into vapour. Dropping a match creates smoke and other particles where rain can form. Pulling the balloon out again lowers the temperature by decreasing the volume enough to start forming clouds.

Applications: Clouds in the sky are formed when water vapour is cooled to form tiny water droplets.

Properties of Water

23.3.3 Test for Water

Materials: Copper (II) sulphate, spoon, candle, water

Procedure: Place a small amount of blue copper (II) sulphate in a metal spoon. Heat the spoon over the candle until the crystals have changed from blue to white. Add a few drops of water to the white crystals.

Theory: On heating blue hydrated copper (II) sulphate, the colour changes from blue ($\text{CuSO}_4 \cdot 5\text{H}_2\text{O}$) to white (CuSO_4). On addition of a few drops of water CuSO_4 returns to its original hydrated state (blue), i.e. copper sulphate pentahydrated.

Importance of Water

23.3.4 Wasted Water



Procedure: Conduct an experiment or survey at your school or village. If you have a dripping tap or leaking pipe, try to find out how much water it wastes each day. Collect the water and measure the volume lost over 15 minutes and then calculate how much would be lost in a day, week, etc.

Applications: Water is essential for all life. Many areas have very little access to water. What can you do in your community to reduce water waste?

23.3.5 Water in Daily Life



Procedure: Ask the students to talk about:

- The importance of water in daily life;
- Where and why water is being polluted;
- How contaminated water may harm people.

Theory: (b) People washing or urinating in/near rivers, lakes; used lubricating oil of cars etc. being dumped on soil may enter the ground water table; factories using chemicals (e.g. tanneries, paper mills, fertilizer plants, pesticide plants etc.) may pollute rivers, lakes etc.

- People may get typhoid fever, cholera etc. when drinking contaminated water from rivers, lakes or wells; water contaminated by factories may cause cancer etc.

Treatment and Purification of Water

23.3.6 The 'SODIS' Method

Procedure: Fill a bottle with water from a tap. Place it on the roof of your house in open sunlight for 2 days or 3-4 days if it is cloudy. Filter through a clean cloth or kanga.

Theory: Ultraviolet rays from the sun kill the harmful bacteria in the water that cause disease. Filtering through a cloth removes solid impurities.

23.3.7 Constructing a Water Filter

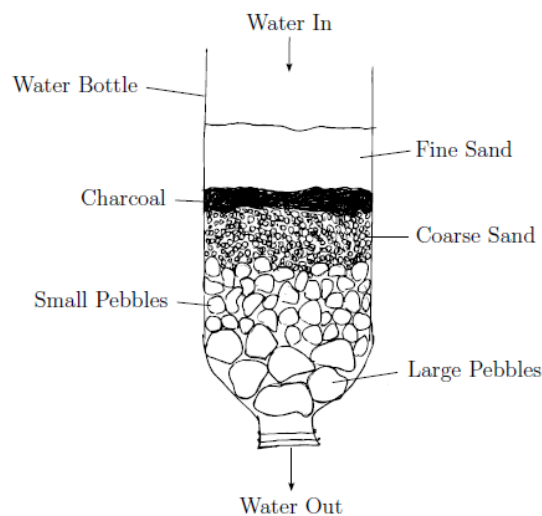

Materials: Fine sand, coarse sand, small pebbles, large pebbles, charcoal, empty bottle, dirty water

Setup: Rinse off all pebbles and remove dirt from the sand. Cut the bottom of a bottle so it is shaped like a funnel.

Procedure: Invert the bottle and place the large pebbles, followed by smaller pebbles, coarse sand, charcoal and sand on top. Run water through until it comes out clean on bottom.

Theory: When dirty water passes through sand particles, impurities are trapped and remain above. The smallest particles and some micro-organisms are stopped by the charcoal layer.

23.3.8 Water Treatment at Home

Materials: Heat Source, pot, water, clean cloth, bucket

Procedure: Boil a pot of water and let it cool. Then pour through a clean cloth or kanga into a clean bucket. The water is now safe for drinking.

Theory: Boiling water at the boiling point (100°C) kills the germs and bacteria which may cause diseases. Filtration with a piece of clean white cloth removes any solid impurities.

23.4 Fuels and Energy

Transformation of Energy

23.4.2 Making an Electric Heater

23.4.1 Chemical to Electrical Energy

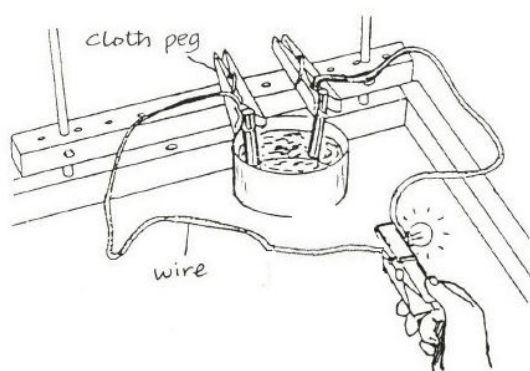

Materials: Copper (II) sulphate, zinc metal (from dry cell), copper wire, steel wool, ammeter/bulb

Setup: Prepare a 2 M solution of copper (II) sulphate and clean pieces of copper wire and zinc using steel wool.

Procedure: Connect the zinc anode, ammeter/bulb and copper cathode in series using connecting wires. Dip the zinc and copper electrodes into the copper (II) sulphate solution. Read the current on the ammeter.

Observations: The ammeter shows a deflection, possibly around 0.05 A.

Theory: The current produced indicates that the chemical energy inherent in the electrodes and the electrolyte solution is converted to electrical energy.

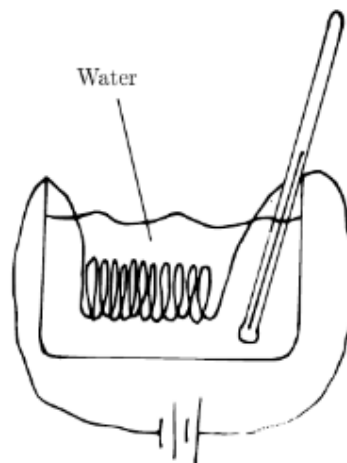

Materials: Nichrome (resistance) wire (1 m), cardboard tube, speaker wire, 2-4 dry cells, water container, thermometer (optional)

Procedure: Coil the resistance wire around a cardboard tube so that the coils are close but not touching. Use speaker wires to connect the ends of the resistance wire to the terminals of the batteries. Place the coil of resistance wire into the container of water.

Hazards: Do not touch the water when current is flowing. If the heater is connected to the cells while not in the water, the wire can melt or burn other objects.

Observations: By touching the water container *on the outside*, it begins to warm up. If left for long enough, the water will begin to boil.

Theory: The electric heater converts electrical energy into heat energy. The larger the coils are, the more efficient the heater will be.

Applications: Boiling water, heating houses

23.4.3 Water Turbine

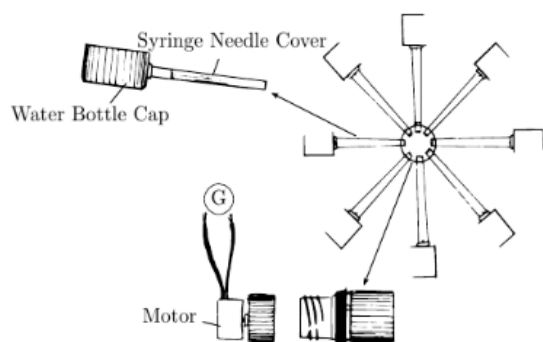

Materials: Plastic bottle, small motor (e.g. from car stereo), super glue, [Heat Source](#), heated nail or soldering iron, 9 water bottle caps, 8 syringe needle caps, scissors, water and pitcher, connecting wires, galvanometer

Water Wheel: Using a hot nail or soldering iron, melt the open end of a syringe needle cap to the side of a water bottle cap to create a sort of spoon. Repeat 7 more times for a total of 8 pieces. Cut the top off a water bottle just below the lip which holds the cap. Melt a plastic cap over the cut end of the bottle top so that the threaded side is open. Use the hot nail or soldering iron to melt 8 holes evenly around the side of this central bottle cap. Insert the 8 spokes into the holes so that they create an 8-spoke wheel with all of the cups facing in one direction at equal distances from the centre. Melt the plastic around each spoke to secure them in place.

Generator: Make a small hole in the centre of the bottle cap using a pin. Glue the top of the cap to the motor wheel so that the two spin together evenly.

Setup: Screw the water wheel onto the generator like closing a bottle. The water wheel should be able to turn freely on the motor. Connect the terminals of the motor to the terminals of the galvanometer.

Procedure: Pour water from a pitcher or spout and place the water wheel under the water so that it turns vertically.

Observations: The galvanometer will deflect to show that a current is being created in the wire.

Theory: Mechanical energy (falling water and subsequent rotating water wheel) is converted into electrical energy (electric current) using a generator.

Alternative Forms of Energy

23.4.4 Windmills

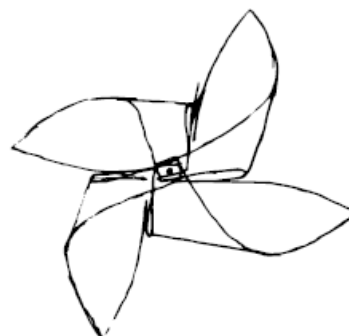
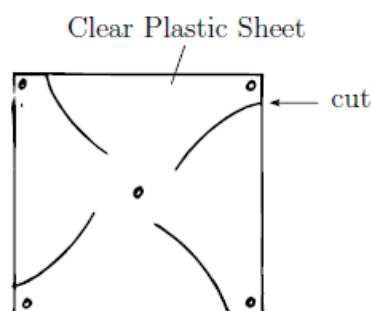

Materials: Paper/plastic sheet, scissors, pen, glue, paper fastener/thumb tack, straw or stick

Procedure: Copy the illustration onto a sheet of plastic or paper. Cut along the lines and make holes with a pen. Bend the four corners together into the center and glue them in place. Push the fastener through the center into a straw or stick.

23.5 Atomic Structure

The Atom

23.5.1 Dalton's Model



Materials: Football, orange, balls of other sizes

Theory: Dalton stated that atoms are round and that the atoms of different elements are not alike in diameter and chemical properties.

Procedure: Let students bring balls of different diameters made from different materials. Let them discuss these models and their shortcomings.

23.5.2 Atom Model Displays

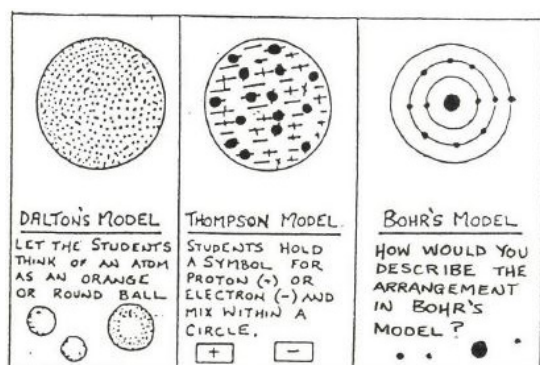

Materials: Manila paper, bamboo sticks, string, paper, marker pens

Procedure: Prepare display charts for the different atomic models developed throughout history (Dalton, Thompson, Rutherford).

23.5.3 Particle Packing

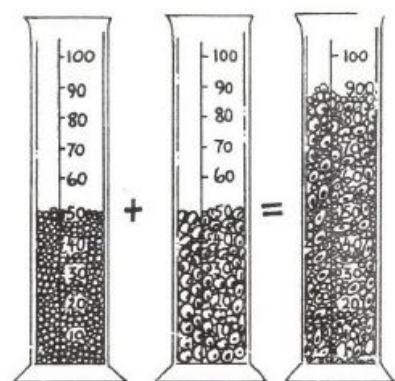

Materials: Measuring cylinders, sand, seeds/stones

Procedure: Mix 50 ml of fine sand with 50 ml of seeds or stones.

Questions: What is the resulting volume?

Observations: The resulting volume is less than 100 ml.

Theory: The small molecules are able to fill the space between the larger molecules. The greater the difference in size, the greater the volume decrease is. This provides a better understanding of Dalton's model.

Sub-Atomic Particles

23.5.4 Student Atoms

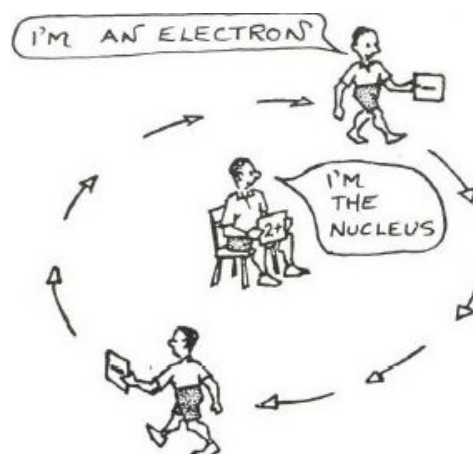

Materials: Balloons or cards/papers, markers

Procedure: Give each student a card or balloon with a different symbol written on it ('+' for proton, '-' for electron, blank for neutron). Students arrange themselves to show a particular atom. Draw circles with chalk on the ground to represent different electron shells.

23.5.5 Models of Atoms

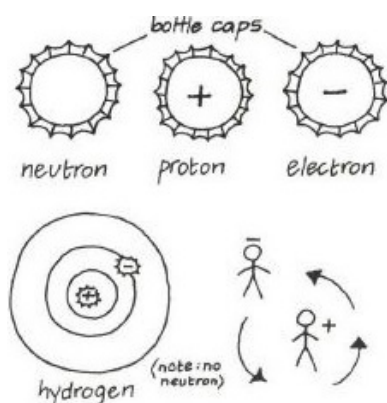

Materials: Bottle caps, marker

Procedure: Label bottle caps at protons ('+'), electrons ('-') and neutrons (blank). Create models for different atoms by placing the appropriate number of protons and neutrons in the center (nucleus) and electrons on drawn circles around the outside. Draw circles on desks or floors to represent the electron shells.

Theory: All atoms contain a nucleus (protons and neutrons) and electrons found in different shells around the nucleus.

Notes: Alternatively use students to represent the electron shells.

23.5.6 Size of the Nucleus

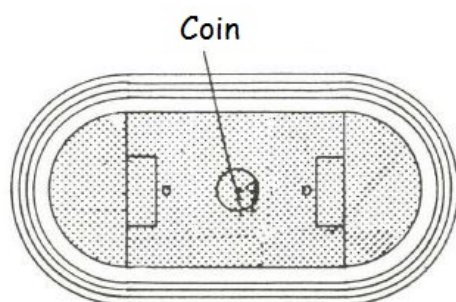

Observations: Ask students to imagine how small the nucleus is compared with the size of the whole atom by thinking of the following comparison. If an atom could be magnified to the size of the National Stadium in Dar es Salaam, then the nucleus would have the size of one coin placed on the centre spot. The rest of the atom is just empty space in which the electrons move haphazardly.

23.5.7 Atoms on the Ground

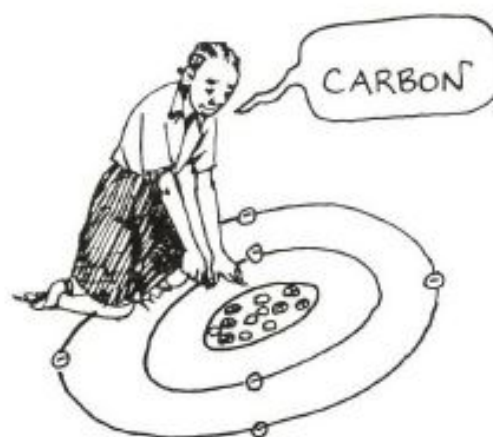
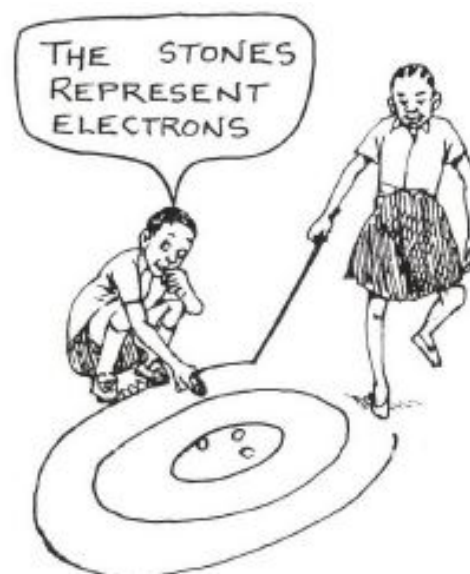

Materials: Bottle caps or stones, string

Procedure: Lay string in circles on the ground to represent the electron shells. Place marked stones or bottle caps to represent protons, neutrons and electrons and construct different atoms.

Electron Arrangements

23.5.8 Dormitory Model

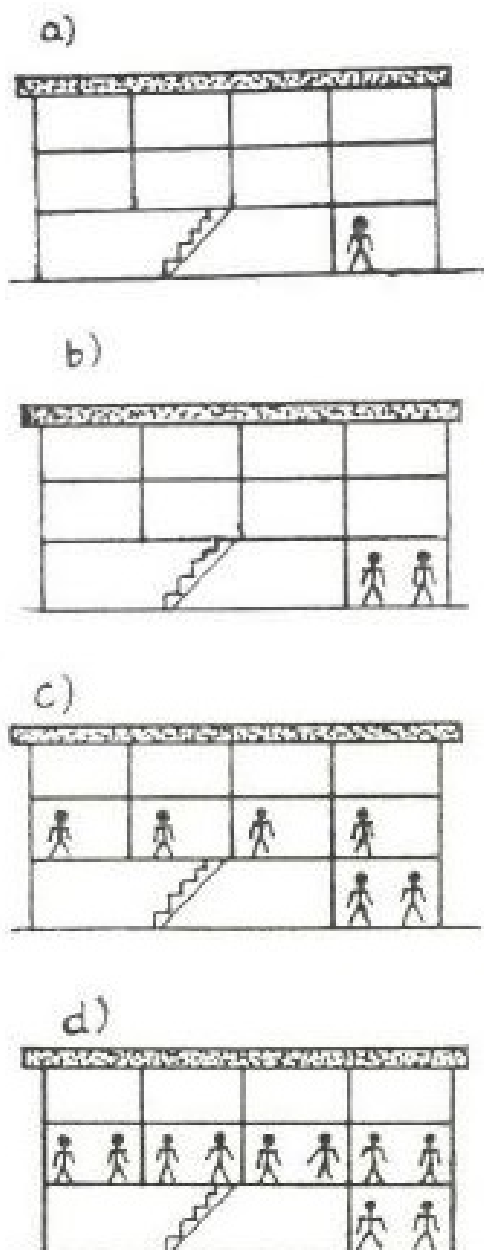

Procedure: Imagine a school has a dormitory with one room on the ground floor, four rooms on the first floor and four rooms on the second floor. The house master has stated that each room must be occupied by two students. However, upper rooms cannot be occupied until all lower rooms are filled. Pairing only occurs when each room on that floor has at least one student.

Theory: This is the same way in which electrons fill electron shells, or energy levels. This configuration is the most stable for electrons.

23.5.9 Shelf Model

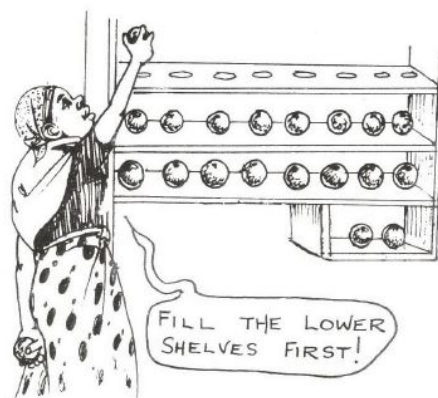

Observations:

Theory: This is an alternative to the school dormitory model. The rules are similar. The upper shelves cannot be occupied until all the lower shelves are occupied by oranges. This is a simpler model since it does not involve the pairing principle.

Isotopes

23.5.10 Isotope Models

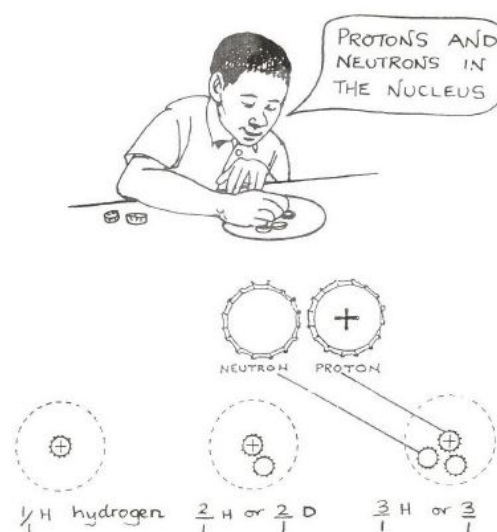

Materials: Bottle caps

Procedure: Cut a large circle from a piece of card to represent the nucleus of an atom. Use bottle caps to represent protons and neutrons. Leave some caps blank for neutrons and mark others '+' for protons. Place bottle caps to show protons and neutrons of some isotopes of hydrogen, oxygen, carbon etc.

Theory: *Isotopes* are atoms of the same element with the same number of protons but different numbers of neutrons. Isotopes of hydrogen are shown.

23.6 Periodic Classification

The Periodic Table

23.6.1 Arranging Shapes

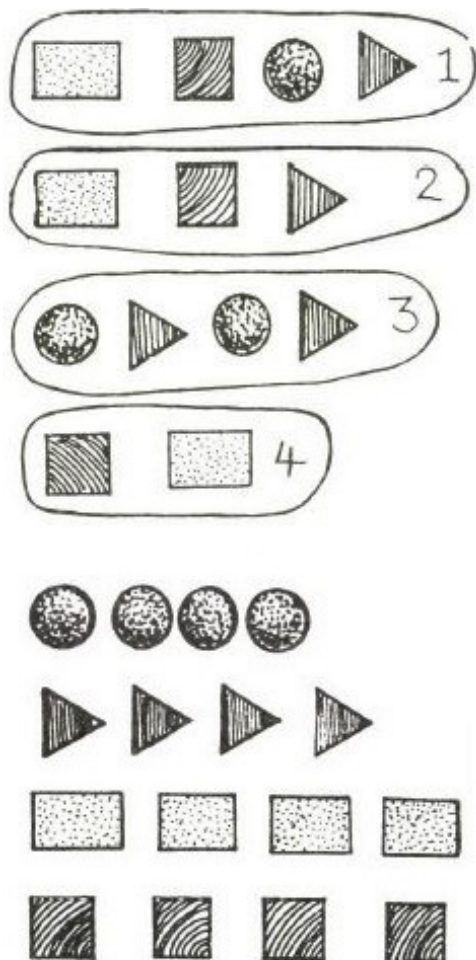

Materials: Paper/manila or card, scissors, coloured pencils or markers

Procedure: Make several of each of the following shapes: squares (3 × 3 cm), triangles (3 cm sides), rectangles (3 × 4 cm), circles (3 cm diameter). Make some of the same shape which are smaller and larger than these as well. Colour them all differently (not according to shape). Mix the shapes and then sort them according to a chosen feature.

Questions: How many different ways can you find of grouping the shapes?

23.6.2 Bottle Cap Periodic Table

P	G R O U P							
	I	II	III	IV	V	VI	VII	VIII
1								
2								
3								
4								
5								
6								
7								

P	G R O U P							
	I	II	III	IV	V	VI	VII	VIII
1	H							He
2	Li	Be	B	C	N	O	F	Ne
3	Na	Mg	Al	Si	P	S	Cl	Ar
4	K	Ca	Ga	Ge	As	Se	Br	Kr
5	Rb	Sr	In	Sn	Sb	Te	I	Xe
6	Cs	Ba	Tl	Pb	Bi	Po	At	Rn
7	Fr	Ra						

Materials: Chalk/manila paper, markers, bottle caps, seeds (optional)

Setup: Ask the students to draw an empty chart of the periodic table. Then let them write the names of the elements inside the bottle caps. Use different colours for metals, semi-metals and non-metals. Bottle caps for all elements are needed.

Procedure: Ask the pupils to place the appropriately labeled bottle caps on the correct squares. As an extension, put seeds around the bottle tops to represent the valence electrons.

23.6.3 Periodic Table Game

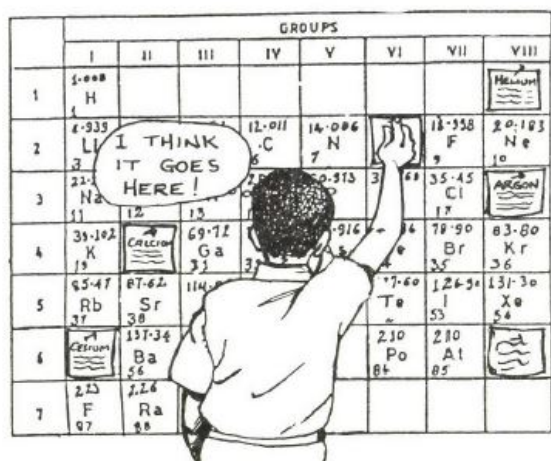

Materials: Manila/flipchart paper, markers, cards, tape

Setup: Create a permanent periodic table on manila or flipchart paper to post in the classroom. Make a series of cards for elements as shown above so they fit into the spaces of your periodic table.

Procedure: Hang or place cards around the classroom and have students each choose one, read it aloud and place it onto the appropriate position of the table. The student should be asked to explain his/her answer. This exercise also helps to develop language skills (speaking and reading).

Notes: You can also give each student one or two elements to make on the cards and then bring them together for the class to share.

23.6.4 Periodic Table Guess Who?



Materials: Paper, beans/seeds/etc.

Procedure: A game for 2 players. Each student thinks of an element from the periodic table. Students take turns asking 'yes' or 'no' questions to determine which element the other is thinking of. For example, "Is your element a noble gas?" or "Does your element have 3 energy levels?" The first player to guess the other player's element is the winner.

Notes: Have students draw a periodic table and use markers (beans, corn kernels, etc.) to cover elements which they have eliminated from their questions.



23.7 Bonding, Formula and Nomenclature

Valence and Chemical Formulae

23.7.2 Ionic Formula Templates

23.7.1 Student Ions

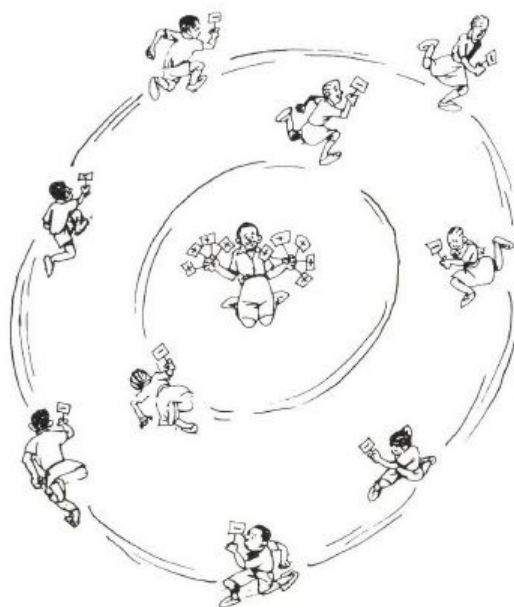

Materials: Cards/paper, students

Setup: Label many cards with symbols to represent subatomic particles ('+' for protons, '-' for electrons, blank for neutrons).

Procedure: Place one chair in a large room to represent a nucleus. Then place chairs in circles around the centre to represent energy levels of electrons - 2 in the first circle, then 8, etc. Have 1 student sit in the middle chair and others in the outer chairs to represent electrons in an atom. Do this for two atoms, e.g. sodium and chlorine. Note that neither atom has a full outer shell. Have students move from one atom to the other in order to fill the outermost shells.

Theory: One atom (often a metal) loses electron(s) and another (usually non-metal) gains electron(s). This results in positively and negatively charged *ions*.

Notes: Adapt this for covalent bonds as well, having students from each atom move to represent shared electrons.

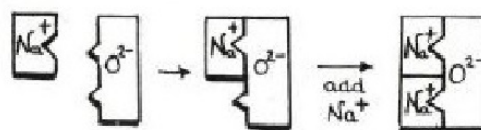
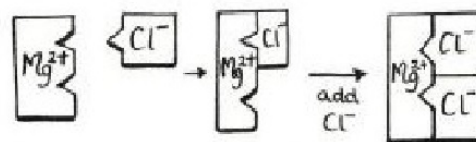
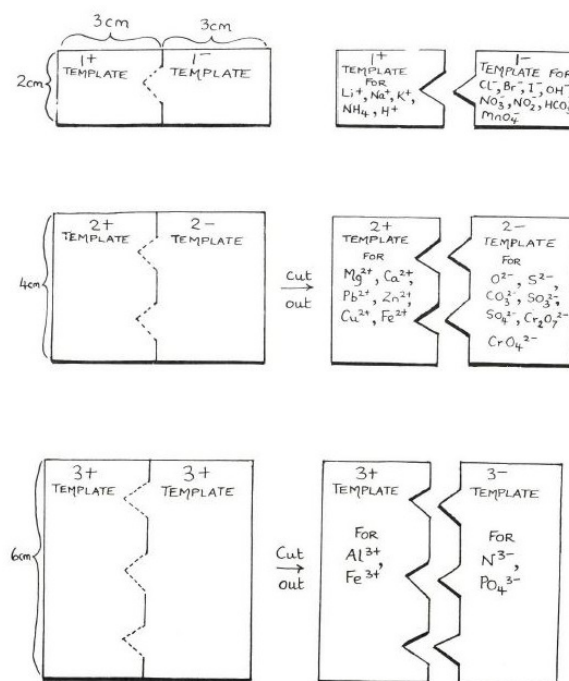

Materials: Cardboard, scissors, markers

Procedure: Cut out templates for different ions as shown. Use them to make different molecule combinations and then write their chemical formulae based on the templates.

23.7.3 Valencies Ruler

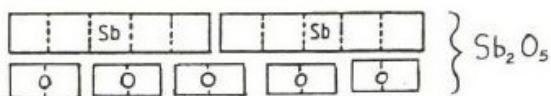
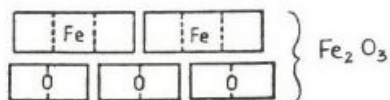
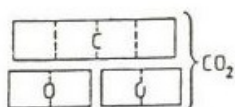
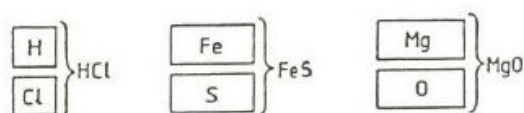
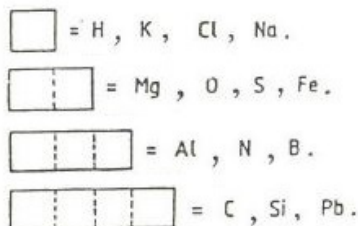

Materials: Cardboard, scissors, markers

Procedure: Measure and cut strips of paper or cardboard as shown in the figure (valency 1 represented by 1 cm × 1 cm card, valency 2 by 1 cm × 2 cm card, valency 3 by 1 cm × 3 cm etc). Write chemical symbols on the strips. For blackboard figure demonstrations the strips can be bigger.

Theory: The valency of an element gives the number of hydrogen atoms which that element can bond to or replace. For example, Group I elements have a valency of 1, and group VI elements such as sulphur have a valency of 8 - 2 = 6.

Chemical Bonding

23.7.4 Covalent Bonds

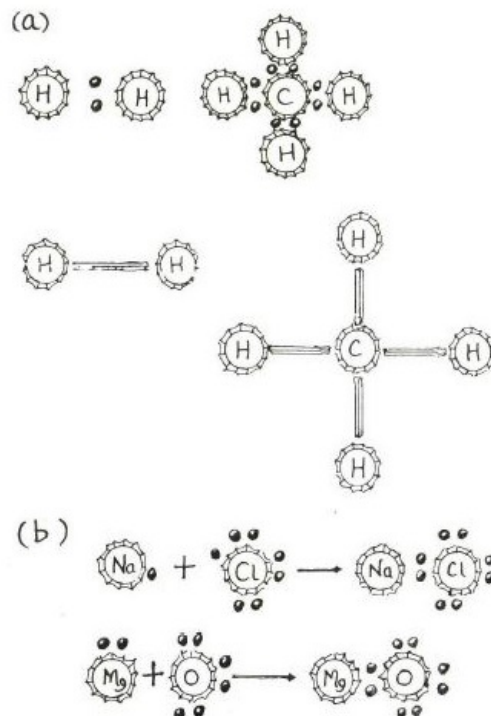

Materials: Bottle caps, matches, peas/seeds

Procedure: Break the heads off of many matches.

A pair of electrons in a covalent bond may be represented by a matchstick without a head, while the heads can be used to represent electrons (a). Ionic bonds can be represented by bottle caps and match heads or stones/seeds as well (b).

Observations: It can be seen that the covalent bonds often fill the outermost energy level for the atoms, thus making the arrangement more stable.

Theory: In covalent bonds, one or more electrons are shared between atoms.

23.7.5 Student Bonding

Materials: Paper, students

Procedure: Give each student a sheet of paper with a different ion written on it. For example, give 1 student a paper reading 'Fe³⁺' and 3 others papers reading 'Cl⁻'. Have the students run around randomly to represent being in an unstable state. Then have them all come together to form a stable molecule of FeCl₃.

23.7.6 Molecule Models



Common elements recommended colour code for models of atoms and molecules	
element	colour
carbon	black
chlorine	green
iodine	purple
hydrogen	white
nitrogen	blue
phosphorus	cream
sulphur	yellow
copper	gold
other metals	silver

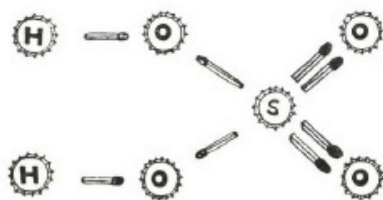
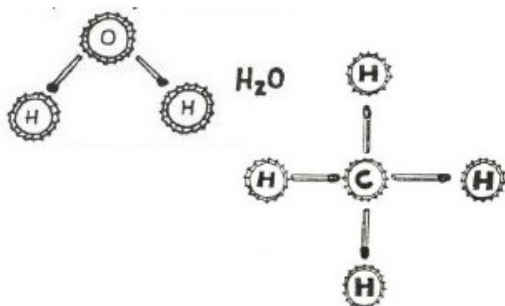

23.7.7 3-D Models

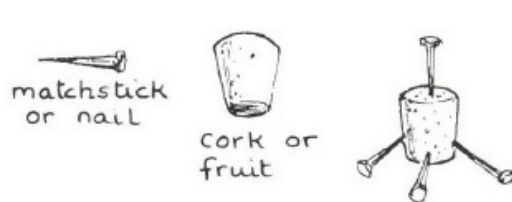
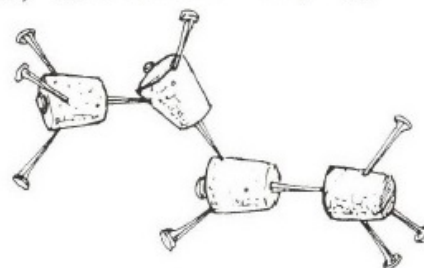
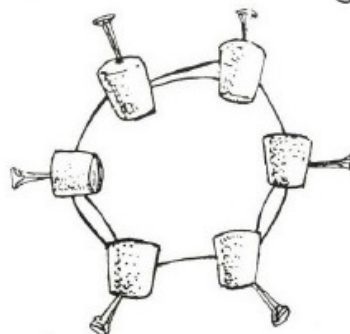
(a) BUTANE C_4H_{10} (b) BENZENE C_6H_6 

(c) AMMONIA



Materials: Bottle caps, matches

Procedure: Mark the bottle caps with a pen or marker. Matchsticks form the bonds. Colour the bottle caps according to the recommendations given to represent different elements. Try to make all the examples in your textbook.

Materials: Cork, nails

Procedure: Use this alternative method for 3-dimensional models of molecules. Nails can represent hydrogen atoms and the corks carbon.

23.7.8 Additional Model Ideas

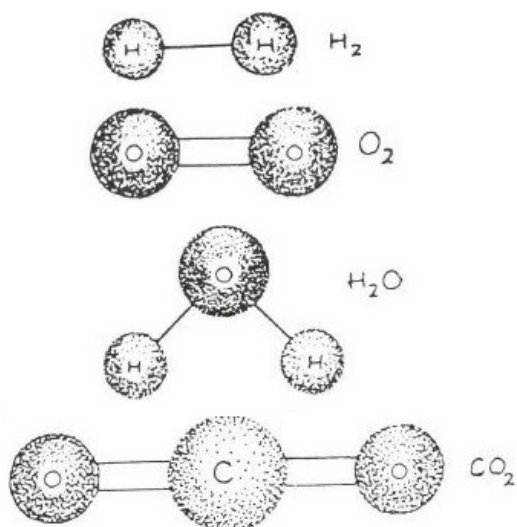

Materials: Small round objects (e.g. fruits, seeds, cork, foam pieces), wire/string/sticks/matches

Procedure: Use the wire, string, etc. for the bonds and the fruits etc. for the atoms. Use the same colour-coding as mentioned above.

23.7.9 Model Box

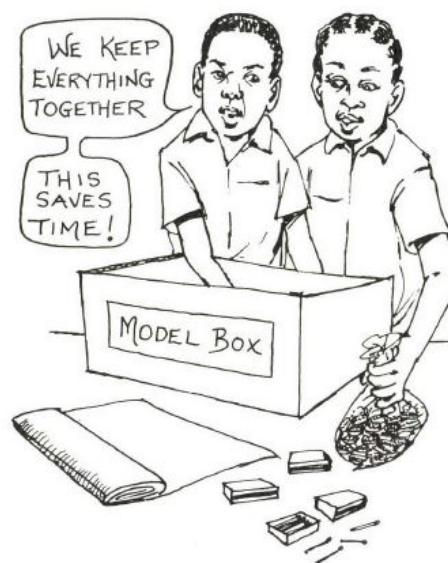

Materials: Cardboard box, bottle caps, matches, seeds/peas/etc.

Procedure: Create a model box for students to use when making models of atoms, molecules, etc.

Chemistry Activities for Form III

24.1 Chemical Equations

24.1.1 Balancing Reactions

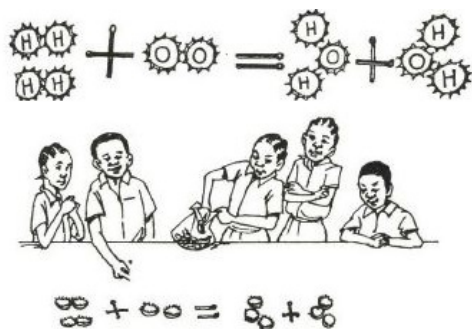

Materials: Bottle caps, matches

Procedure: Use bottle caps and matches to construct the reactants and products of a chemical reaction (e.g. $2\text{H}_2 + \text{O}_2 \longrightarrow 2\text{H}_2\text{O}$).

Observations: It can be seen visually how atoms rearrange to form new molecules.

24.1.2 Combination Reactions

Materials: Sulphur, steel wool, [Heat Source](#), spoon, bar magnet, bottles

Procedure: Grind the steel wool to get fine particles. Place a small amount in a bottle and add an equal amount of sulphur powder. Hold a magnet above the mixture and observe. Then heat a small amount of iron filings with twice as much sulphur until the sulphur powder is gone. Again try to separate the mixture with a bar magnet. Finally heat a mixture of the two for an extended time and try to separate with a magnet.

Hazards: This reaction produces sulphur dioxide, a poisonous gas. Perform outside or in a well-ventilated room.

Theory: Combination is the kind of chemical reaction where two elements come together to form a single compound. The mixture can easily be separated before heating because the iron is magnetic while the sulphur is not. When heated, the iron and sulphur combine to form iron (II) sulphide. Because the two are bound together, they cannot be separated by physical means. When heated for a long time, however, the sulphur escapes as sulphur dioxide, leaving behind iron oxide (a metal) which can be picked up with a magnet.

24.1.3 Precipitation Reactions

Materials: Copper sulphate, soda ash (sodium carbonate), containers, funnel, cloth

Setup: Make solutions of copper sulphate and sodium carbonate by mixing a spoonful in about 500 mL of water (in separate containers).

Procedure: In a container, combine a small amount of each solution and filter using a cloth or toilet paper.

Theory: A precipitate reaction is the formation of an insoluble salt by mixing solutions which contain its two components. When copper sulphate solution is mixed with sodium carbonate a blue precipitate (copper carbonate) will form. This reaction is useful for preparing insoluble salts. The chemical reaction is:
$$\text{CuSO}_{4(\text{aq})} + \text{Na}_2\text{CO}_{3(\text{aq})} \longrightarrow \text{CuCO}_{3(\text{s})} + \text{Na}_2\text{SO}_{4(\text{aq})}$$

24.1.4 Decomposition Reactions

Materials: Copper carbonate, citric acid, spoon, [Heat Source](#)

Setup: Dry the copper carbonate from the precipitation reaction by leaving in an open container.

Procedure: Heat a small sample of copper carbonate in a spoon until only a black residue remains. Add a small amount of citric acid and heat again until only a black residue remains.

Theory: Thermal decomposition is when a compound breaks down when heated. When copper carbonate is heated, it decomposes to release carbon dioxide. The black residue can be found by subtracting carbon dioxide from the formula for copper carbonate:

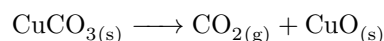

When citric acid is heated, it decomposes twice. First, bubbles of carbon dioxide are released and then, citric acid further decomposes to release water vapor. The black residue at the end of the experiment is solid carbon.

24.2 Hardness of Water

Concept of Hardness of Water

24.2.1 Is the Water Pure?

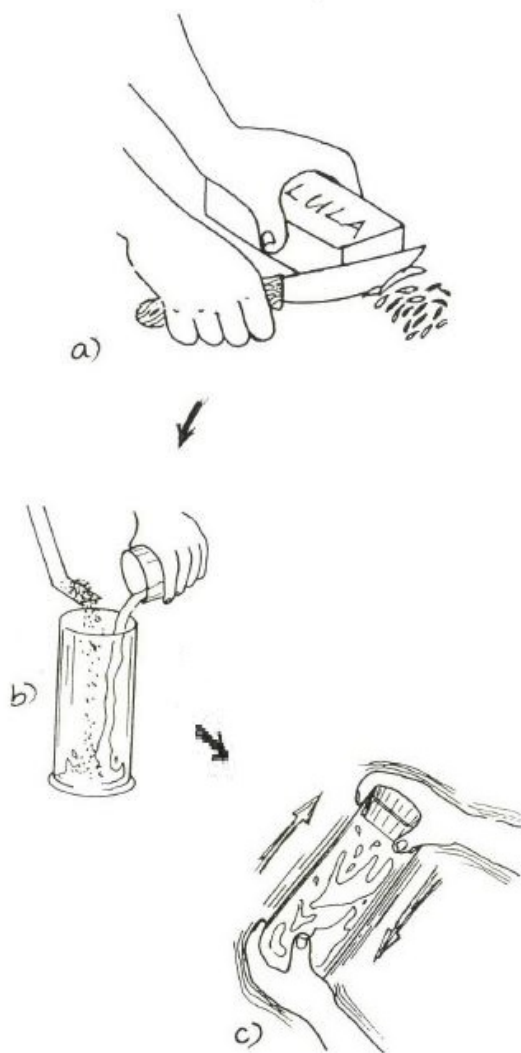

Materials: 2 bottles, tap water, rain water, soap

Procedure: Fill one bottle with tap water and another with distilled water (rain water). Add equal amounts of soap into each and shake well.

Observations: Soft water foams easily, but hard water will form a scum (white precipitate) and little foam. Distilled water, because it is soft, will foam easily.

Theory: Hard water is caused by dissolved solids. However, a part of the hardness can be removed by boiling. Hence, if hard tap-water is boiled, it can become softer.

Types of Hardness of Water

24.2.2 Temporary and Permanent Hardness

Materials: Bottles, syringes, soap, Epsom salt (magnesium sulphate), bicarbonate of soda (sodium hydrogen carbonate), Heat Source, rain water, filter paper, funnel, washing soda (sodium carbonate)

Setup: In one bottle add a spoonful of Epsom salt with 2 spoons of bicarbonate of soda and water. Stir until the salts dissolve. In a second bottle add a spoonful of Epsom salt with water and stir until dissolved. In a third bottle add rain water. Label the bottles "temporary hard water," "permanent hard water" and "soft water," respectively. Prepare a separate sodium carbonate solution by dissolving 2 spoons of washing soda into 500 mL of water.

Procedure: In 3 separate syringes put approximately 5 mL samples of each solution, add soap and shake vigorously. Repeat but instead add a few drops of sodium carbonate solution. Boil a small amount of both temporary and permanent hard water. To the boiled permanent hard water, add a few drops of sodium carbonate. Filter the precipitate from the boiled temporary hard water and add a few drops of sodium carbonate.

Theory: Magnesium sulphate mixes with sodium hydrogen carbonate solution to produce an aqueous solution of magnesium hydrogen carbonate (temporary hard water). Magnesium sulphate solution is permanent hard water. When the temporary hard water is boiled, a white precipitate of magnesium carbonate should be observed. Boiling the permanent hard water will not cause precipitation. The precipitation occurs because the hydrogen carbonate decomposes on boiling to form a carbonate which then precipitates with magnesium ions.

On boiling:

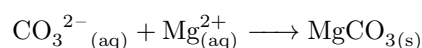

After boiling and filtering, the sodium carbonate can indicate the presence or lack of magnesium ions. In the soft water and the boiled, filtered temporary hard water, no precipitate will be observed because there is no magnesium ion is present. In the permanent hard water, a precipitate will be observed with sodium carbonate

Treating Hard Water

24.2.3 Removing Hardness

Materials: Rock soaked in hard water, vinegar, water, bucket

Procedure: Place a rock or other object with hard water remains on it in a bucket. Add equal parts vinegar and water to cover the object and let it sit overnight.

Observations: The remains of the hard water will dissolve.

Theory: Hard water contains dissolved magnesium or calcium ions. Soft water does not. Calcium and magnesium carbonates dissolve easily in vinegar, and it is difficult to dissolve them back into water.

24.2.4 Effect of Soda on Hard Water

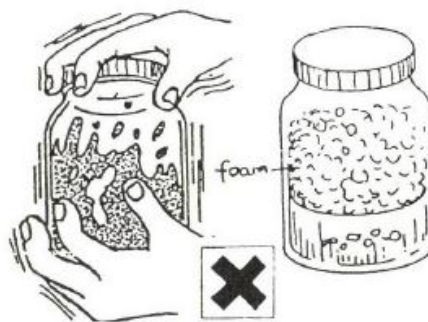

Materials: Water, soap, bottle, washing soda (sodium carbonate)

Procedure: Add some ash extract or washing soda to tap water and shake well. Filter and add soap and shake as described in [Is the Water Pure?](#) (p. 97).

Observations: A lot of foam is formed this time.

Theory: The water has been softened by this process. The soda (sodium carbonate) precipitates the Ca^{2+} and the Mg^{2+} ions (which cause the hardness) as the respective carbonates which are filtered off.

24.3 Acids, Bases and Salts

Acids and Bases

24.3.1 Acids in Daily Life

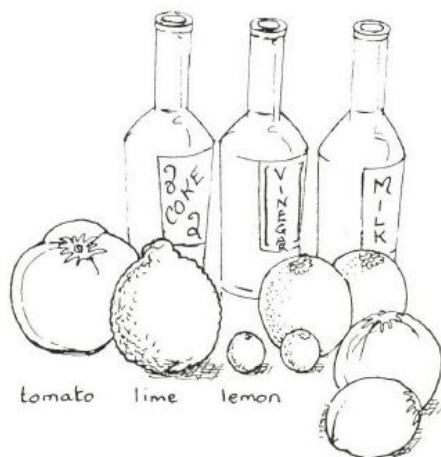

Procedure: Make a list of common acids seen in daily life.

Observations: Citrus fruits (tomatoes, oranges, lemons etc.), vinegar, soda, sour milk and battery fluid are examples of everyday acids.

24.3.2 Bases in Daily Life



Procedure: Make a list of common acids seen in daily life.

Observations: Soap, bicarbonate of soda, toothpaste, ammonia, limewater, cheese, fish, meat and indigestion tablets are all sources of bases.

24.3.3 Acids React with Metals

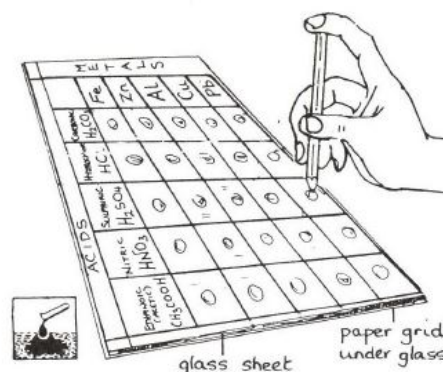

Materials: Syringe, sulphuric acid, zinc (from old dry cell)/nail/aluminium can

Procedure: Using a syringe, add a small amount of acid to various metals on a glass sheet.

Hazards: Do not use highly concentrated acids and wear goggles.

Observations: A gas is produced.

Theory: The gas produced is hydrogen, which can be confirmed with the 'pop' test of holding a match nearby.

24.3.4 Acids React with Carbonates

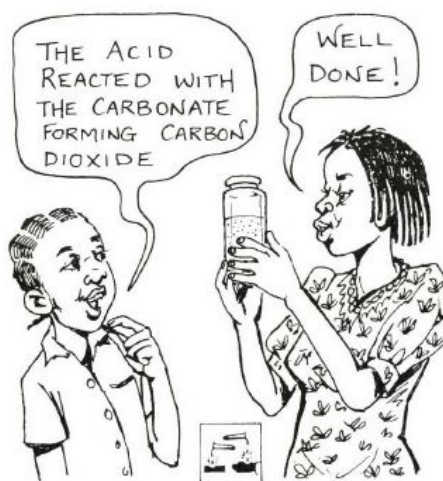

Materials: Bottle cap, dilute acid, baking powder, straw

Procedure: Add a few drops of dilute acid (e.g. vinegar, citric acid) to a bottle cap full of baking powder.

Theory: Acid react with carbonates to form carbon dioxide.

24.3.5 CO₂ Balloon

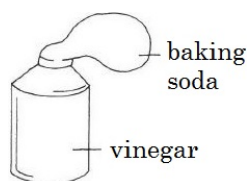

Materials: Bottle, baking soda, vinegar, balloon

Procedure: Add a small amount of vinegar into a bottle. Fill a balloon with baking soda (bicarbonate of soda) and stretch the balloon over the mouth of the bottle. Lift the balloon to empty the contents into the bottle.

Observations: The balloon fills up with gas and may even explode!

Theory: The vinegar (acid) and baking soda (base) combine to produce carbon dioxide gas, which gets collected in the balloon.

24.3.6 Making a Volcano

Materials: Flour, sand, water, glue, vinegar, bicarbonate of soda, food colour

Setup: Create a model volcano. Add food colour if desired.

Procedure: Fill the pit of the volcano with bicarbonate of soda (with red food colour) and pour in the vinegar.

Observations: A foamy 'lava' erupts from the volcano.

Theory: Acids and bases react to produce a salt, carbon dioxide and water.

Applications: Use this as a science fair experiment at your school.

24.3.8 Making Indicators



Materials: Coloured flowers, fruits, leaves, water, Heat Source

Procedure: Gather different coloured flowers, fruits or leaves. Crush them up and add to boiled water or spirit.

Theory: Many red, violet, yellow or pink flowers or fruits and leaves can be used as indicators. Spirit-based indicators are more stable. Boiling improves the extraction of colour.

Applications: Students could investigate which local flowers, leaves etc. produce the most effective indicators.

Indicators

24.3.7 The pH Scale Line



Materials: Paper, various acids and bases shown

Procedure: Use chalk or string with paper numbers to mark out a pH scale in the classroom. Select some of the items shown and give one to each student. Ask the student to stand at the correct place on the scale.

24.3.9 Testing for pH

Materials: Rosella leaves, paper, straw, hot water, lemon or vinegar, bicarbonate of soda

Setup: Prepare an indicator solution from rosella leaves by crushing and adding to boiled water.

Procedure: Place a small amount of vinegar or lemon juice to one bottle cap and some bicarbonate of soda to another. Add a few drops of indicator to each cap, noting any colour changes that occur.

Theory: The vinegar should turn a reddish colour, indicating it is acidic. The bicarbonate of soda a greenish or blue colour, indicating it is a basic.

Notes: Dip thin strips of paper in the indicator solution and let dry to make home-made litmus paper.

24.3.10 Exchanging Fluids

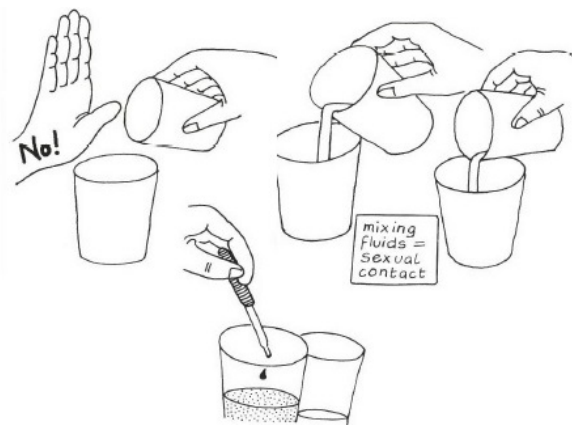

Materials: Plastic bottles, plastic bags, rubber bands or tape, phenolphthalein indicator, sodium hydroxide

Setup: Make a solution of NaOH (3-5 tablespoons in 500 mL water). The concentration should be enough so that multiple dilutions of the solution will still show a colour change when PoP is added. Cut enough plastic bottle cups so each student has one. Number each cup and separate into 3 groups (those who abstain, those who use condoms, and those who neither use condoms nor abstain). Make note of which numbers are in which group (but do not reveal until later). There should be at least 2 that abstain, 2 that use condoms, and the rest use neither. No more than 2 people total should start HIV positive (at least 1 being a sexually active non-condom user). Fill all the cups except the ones that will be HIV+ with about 100-200 mL of water. Fill the HIV+ cup(s) with the NaOH solution, making sure the volume is the same as the water-filled cups. Take the plastic bags (condoms) and secure them over each condom user's cup with tape or a rubber band. The plastic should have a slight dip so fluid can still be poured into it while preventing the fluids from mixing.

Procedure: Introduce the activity by stating that 1-2 of the cups is HIV+ but do not reveal which one(s). Announce which cup numbers will abstain (meaning which ones will not share fluids with anyone), which ones use condoms (meaning they can receive fluids but do not share them), and which ones use neither (meaning they will be exchanging fluids multiple times with multiple people). Show students that 1 of the non-condom users does not have HIV by adding 1-2 drops of PoP with no colour change. Then take a small sample of leftover NaOH solution and add 1 drop of PoP. Explain that a colour change to

pink/purple, even very slight, means they are HIV+. Randomly give out the different cups and tell students to take 10-15 minutes to exchange fluids with others. Encourage them to return to other "partners" and exchange multiple times. (It is recommended that students mix fluids by pouring so enough fluid is transferred between the two cups.) After the time is up and enough exchanging of fluids has occurred, test every student's cup with 1-2 drops of PoP.

Hazards: Be careful when using concentrated NaOH. It can be very caustic if not handled with care. Neutralize spills with a weak acid (e.g. vinegar).

Questions: Which students ended up being HIV+ and why? How quickly did HIV spread?

Observations: If done correctly, every student except those who abstained or used condoms should test positive for HIV, as seen by a change in colour from the indicator.

Theory: Sodium hydroxide solution is a base, and bases turn pink/purple when PoP is added. Even though NaOH is colourless and difficult to tell apart from water (just as HIV+ people are difficult to tell apart from HIV- people), once it is present, it does not go away and can be spread very easily without protection. The activity also shows that even though there was only 1 or 2 people to start with HIV, it spread to practically every person who exchanged fluids (sexually active).

Applications: It is important to prevent oneself from getting HIV, and abstinence and using condoms are two highly effective methods of getting HIV.

Notes: Instead of using PoP indicator and a strong base, iodine can be used to test for starch. The same setup and procedure is followed, except the starch solution can be water from boiling potatoes, etc. Just make sure the starch solution and water are not distinguishable.

Additionally, this activity can be used to explain the spread of malaria. Instead of every person exchanging fluids, there are 2 main groups: humans and female mosquitoes. This time, only students with syringes (female mosquitoes) inject their solution (saliva) into the human and suck the human's solution (blood) into their own cup. The sucking and injecting should again happen multiple times with multiple people. There can be different groups of humans (those who use mosquito nets, who do not get bit at all, etc.) and no more than 2 female mosquitoes should carry malaria to start.

Neutralisation

24.3.11 Neutralisation Reactions

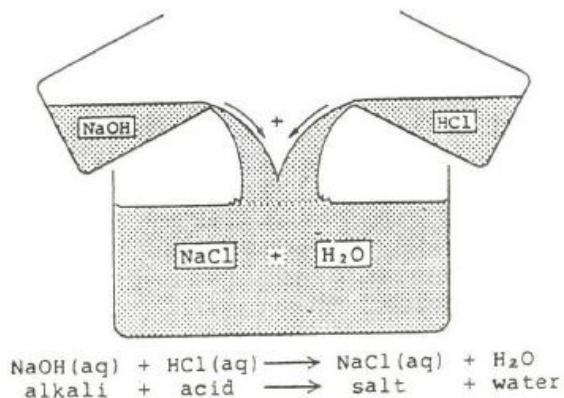

Materials: Sodium hydroxide solution, hydrochloric acid solution, bottles

Procedure: Prepare dilute solutions of sodium hydroxide and hydrochloric acid. Pour the two solutions together in a large container.

Hazards: Never use concentrated acids. Always wear goggles when using acids.

Theory: When acids and bases combine, they produce a salt and water. In this case the salt is sodium chloride. The resulting solution is neither acidic nor basic, but neutral.

24.3.12 Ant Acid



Applications: Many insects, such as bees and ants, inject an acidic liquid into the skin when they sting. The sting can be neutralized by rubbing baking soda (or other alkaline substances such as cucumber and avocado) on the affected area. Wasp stings, however, are alkaline and can be neutralized with vinegar (acetic acid).

24.3.13 Neutralisation in Daily Life

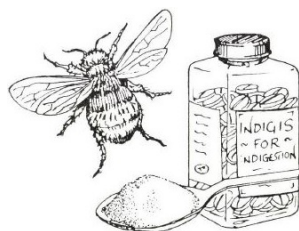

Applications: Stomach aches are often caused by an excess of acid in the stomach. Taking antacids (magnesium or sodium bicarbonate) neutralizes the acid and relieves the pain.

Salts

24.3.14 Preparation of Salts



Materials: Bottle cap, zinc (from dry cell), hydrochloric acid

Procedure: Add some zinc (found in dry cells) to hydrochloric acid.

Theory: Acids and metals react to form salts. The chemical equation for this reaction is:
 $\text{Zn(s)} + 2\text{HCl} \longrightarrow \text{ZnCl}_2\text{(s)} + \text{H}_2\text{(g)}$

24.3.15 Solubility of Salts

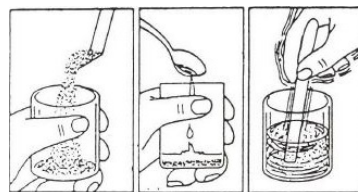

Materials: Bottle caps, water, kitchen salt (sodium chloride), baking soda (sodium hydrogen carbonate), copper (II) sulphate, gypsum (calcium sulphate)

Procedure: For each salt: add a bottle cap full of salt to 5 caps of water and shake well. Observe which salts dissolve in water.

Observations: All salts should dissolve except for gypsum (calcium sulphate).

Theory: Most sulphates, nitrates and chlorides are soluble in water, while most carbonates are not. Calcium sulphate and sodium carbonate are exceptions to these general rules.

24.4 The Mole Concept and Related Calculations

The Mole as a Unit of Measurement

24.4.1 Mole as a Number of Particles

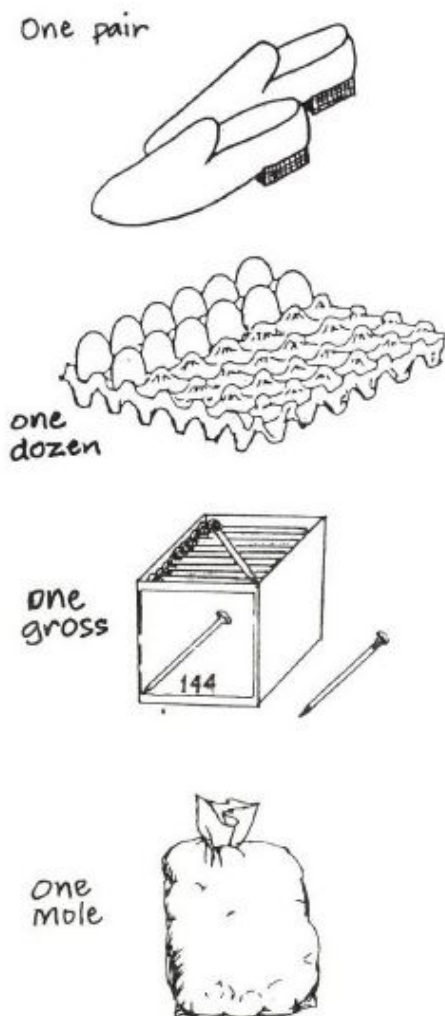

Theory: To show that 1 mole is a number of particles or pieces, show that 1 pair = 2 pieces, 1 dozen = 12 pieces, 1 gross = 144 pieces, 1 mole = 6.022×10^{23} particles.

24.4.2 Avogadro's Number

Theory: To illustrate the magnitude of Avogadro's number the following comparison can be made: If 1 cm³ cube of water contains 20 drops of water then Avogadro's number, $N = 20 \times$ the number of drops in all the oceans of the world.

24.4.3 Introducing Particle Masses

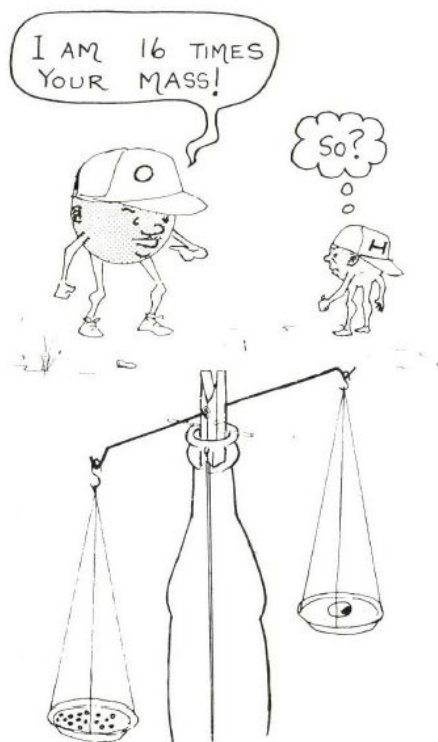

Materials: Balance, large seed, small seeds

Procedure: Take a balance and one stone/ big seed and weigh how many other seeds make up the same weight. Make sure the objects are at the same distance from the pivot.

Theory: Different particles have different masses. The molar mass of a substance is a measure of the weight of a given number of particles of that substance. The standard number of particles used for comparing molar masses is a mol of particles (or 6.022×10^{23}).

24.4.4 Understanding Atomic Mass 24.4.5 Molar Volume of Gases

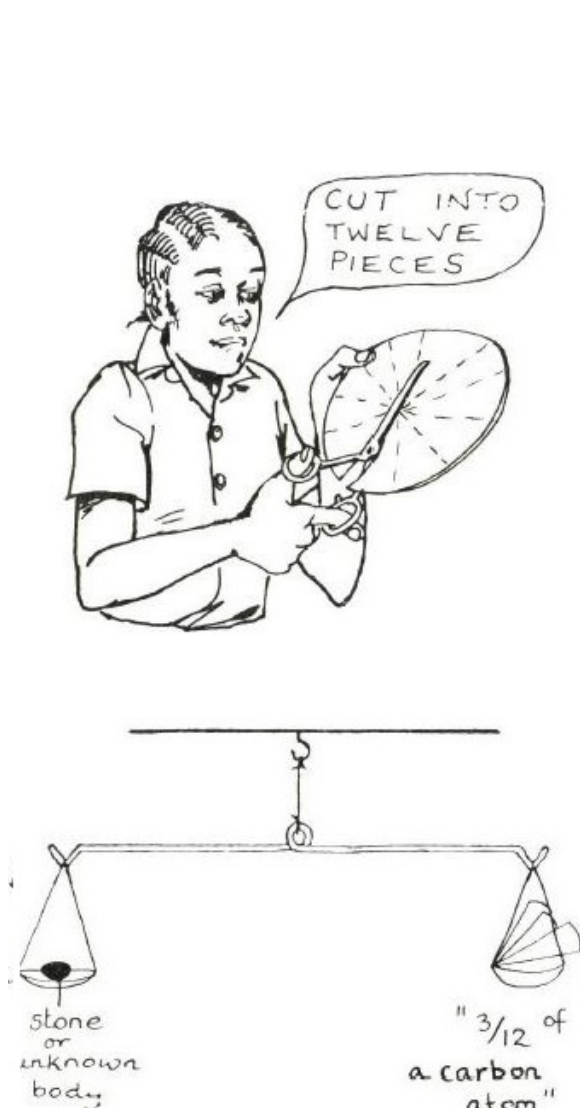

Materials: Cardboard, scissors, balance

Procedure: Make a cardboard disc from thick cardboard. Divide into 12 parts and cut these out. One part represents $1/12$, i.e. $1/12$ of a carbon atom. Now try to find out by weighing what the masses of some unknown bodies are. These should be heavier than 1 and not exceed 12 pieces.

Theory: The mass of an object (atom) can be expressed relative to that of another. This is the concept behind molar mass.

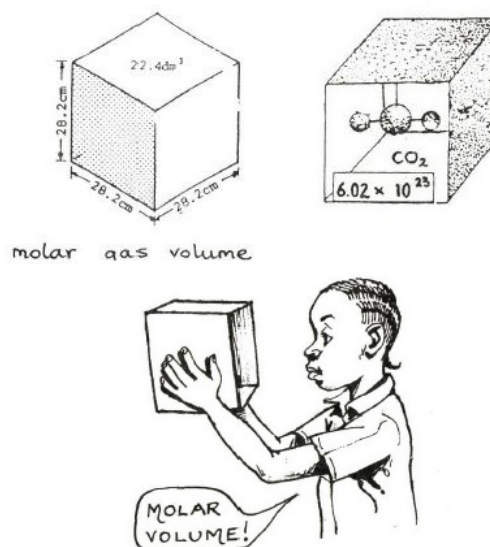

Materials: Cardboard, scissors, tape

Procedure: Cut out six 28.2×28.2 cm pieces of cardboard. Assemble them to form a cube of volume 22.4 dm^3 . Construct models of different molecules and place/hang these in the box in order to show that the 22.4 dm^3 volume is filled with the same type and number of gas molecules. Then write Avogadro's number and attach it to the molecule model, and explain that in one molar volume, there is that number of particles.

24.4.6 Molar Volume of Solids and Liquids

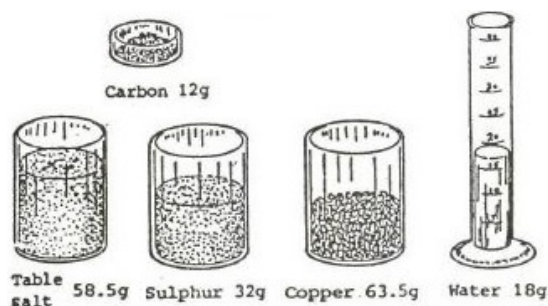

Materials: Cups, water, various powders (e.g. carbon, sulphur, copper, salt)

Procedure: If you have a suitable balance, weigh out one mole of various substances as shown in the figure.

Theory: The molar volume of different solids and liquids is very different. Only the molar volumes of gases - at the same temperature and pressure - are the same.

Notes: To measure water, use 18 mL, since $1\text{ mL} = 1\text{ cm}^3$ and the density of water is about 1 g/cm^3 .

24.4.7 Avogadro's Law

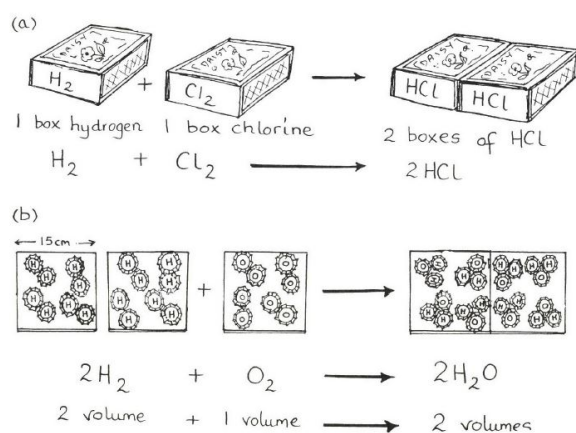

Materials: Matchboxes, bottle caps

Observations: Each matchbox (all the same size) represents the same volume and each molecule in it the same number of particles.

Theory: Avogadro's Law states, that at the same temperature and pressure equal volumes of different gases contain the same number of particles.

Applications: Chemical reactions may lead to same or different volumes, e.g. in HCl and H_2O formation respectively.

Dilution

24.4.8 Salt Dilution

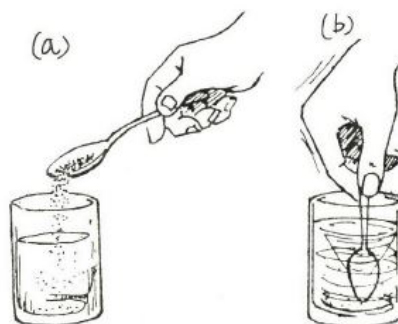

Materials: Salt, syringe, water, 5 bottles, food colour (optional)

Procedure: In one bottle, add 100 mL water and enough salt to saturate the solution. With a syringe remove 10 mL and add to another bottle with 90 mL of clean water. Now take 10 mL of this solution and add to another bottle with 90 mL of clean water. Repeat this several times, tasting a bit of each solution as you continue.

Observations: The solution tastes less salty each time.

Theory: The ratio of solute to solvent (salt to water) decreases each time fresh water is added. Hence, the solution becomes more and more diluted.

Notes: Try also using food colour for a visual representation.



24.5 Ionic Theory and Electrolysis

24.5.1 Displacement of Copper

Materials: Steel wool, copper (II) sulphate, water, bottle

Setup: Prepare a copper (II) sulphate solution by dissolving a spoonful of crystals in about 500 mL of water.

Procedure: Pour 50 mL of the copper (II) sulphate solution into the container. Dip the steel wool into the solution and observe what happens.

Observations: A layer of brown copper metal forms on the surface of the steel wool (this is not rust).

Theory: Metals can be arranged according to their reactivity, i.e. how likely they are to form positive ions. A metal higher in the reactivity series will displace a lower metal from a solution.

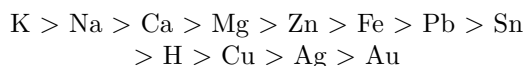

Iron is higher than copper on the reactivity series, meaning iron ions displace copper ions in solution and the copper ions are deposited as copper metal.

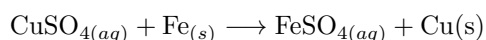

24.5.2 Reactivity Rates Analogies



24.5.3 Reactivity Series of Metals

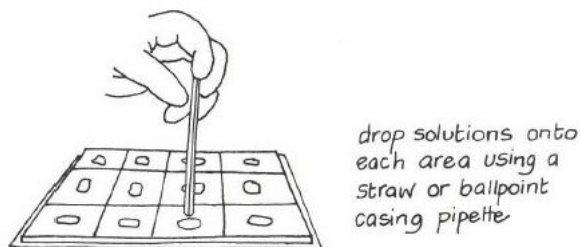
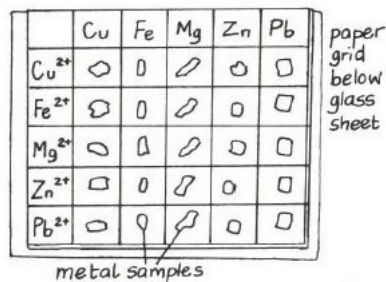

Materials: Glass sheet, large sheet of paper, metals, solutions of metal ions (see below)

Setup: Gather and clean small pieces of various metals (e.g. copper wire, iron wool, magnesium ribbon, zinc plate from dry cell, lead shot). Gather some solutions containing metal ions (e.g. copper (II) sulphate, iron (II) sulphate, magnesium sulphate, zinc sulphate, lead nitrate).

Procedure: Make a grid on the paper as shown. Place the glass sheet over the paper grid. Place the metals on the appropriate squares. Add 2-3 drops of a solution to each metal and observe and change.

Observations: On some of the squares a black or red (in the case of copper displacement) coating is formed on the surface of the metal.

Theory: If a black coating forms on the metal it indicates that the metal ions are being displaced from the solution and deposited onto the metal. This shows that the metal is more reactive than the ion in solution. For example if Fe^{2+} ions in solution are dropped onto magnesium, the magnesium displaces the Fe^{2+} ions and a black coating of iron can be seen on the surface of the magnesium.

Electrolytes and Non-Electrolytes

24.5.4 Electrolytes

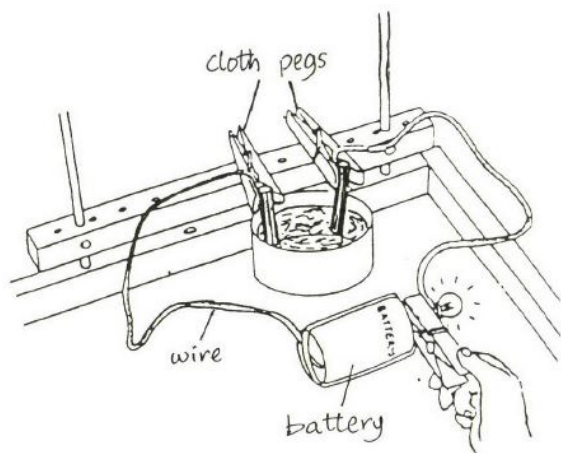

Materials: Table salt, distilled water, sugar, vinegar/citric acid, sulphuric acid, bottles, dry cells, clothes pegs, bulb/ammeter, speaker wire, 2 carbon electrodes (from dry cell)

Setup: Connect the circuit in series as shown. Take carbon electrodes from an old dry cell.

Procedure: Place the two carbon electrodes in a container of water. On a piece of paper, pour out some table salt crystals and touch the electrodes to them. Dissolve the salt in the water and again test for conductivity. Repeat with citric acid crystals and solution, then sugar crystals and solution, rinsing the electrodes between tests. Finally test the electrodes in a dilute sulphuric acid solution, rinse, then in vinegar.

Theory: Bubbles of gas at the electrodes indicate the flow of an electric current. Substances which conduct electricity in solution are called *electrolytes*. No substance will conduct electricity in the solid state but some of them will conduct in the dissolved state. Sodium chloride (table salt) is a *strong electrolyte* - the bulb burns brightly. Vinegar and citric acid are *weak electrolytes* - the bulb burns dimly. Sugar is a *non-electrolyte* - the bulb does not light. The bulb is brighter in sulphuric acid solution than in vinegar even though they are about the same concentration, because the sulphuric acid dissociates completely while citric acid/vinegar only partially dissociate into ions.

24.5.5 Electrodes

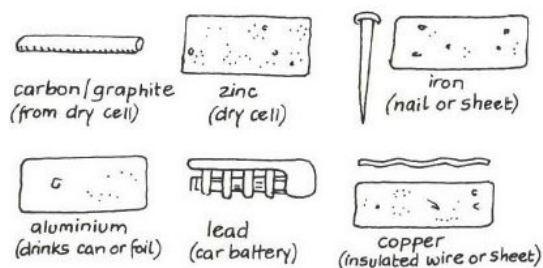

electrolytes	cathode	anode
HCl (half-conc)	graphite	graphite
alkali chlorides (2M)	iron / graphite	graphite
alkali hydroxide (2M)	iron	iron
H ₂ SO ₄ (2M)	lead or graphite	lead
Na ₂ SO ₄ (16%)	iron	lead
Cu SO ₄	graphite	graphite or lead

Theory: The materials shown here can be used as electrodes in electrolysis activities. Use the table to find the appropriate matching of electrolyte and electrodes.

24.5.6 Electrolysis Setups

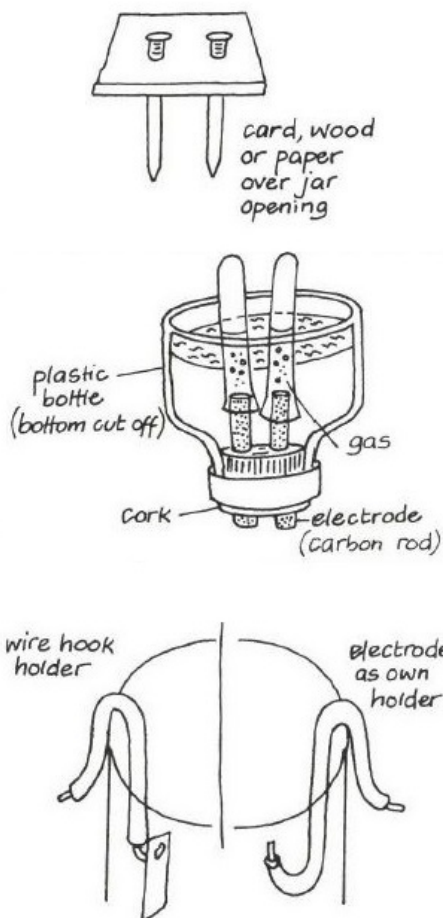

Procedure: Use any of the designs shown for setting up electrolysis experiments.

24.5.7 Electrolytes in Food

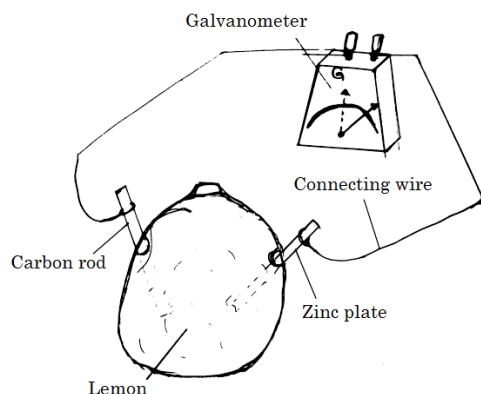

Materials: Lemons, zinc plate and carbon rod from old dry cell, connecting wires, galvanometer, bulb

Procedure: Make two holes in a lemon and insert the carbon rod and zinc plate into the holes. Connect the lemon to the galvanometer using connecting wires and notice any deflection that may occur. Repeat for several lemons by placing them in series and in parallel.

Observations: The deflection increases with the number of lemons placed in series. With enough lemons, the bulb will light up.

Theory: Electric current can be produced from different cells - dry and wet. Wet cells can be made from natural foods such as lemons, Irish potatoes and salts which are strong electrolytes and hence produce electric current.

Mechanism of Electrolysis

24.5.8 Electrochemical Series

Materials: Paper, marker pens, tape

Setup: Tape sheets labeled "Cathode" and "Anode" on opposite walls of the room. Make signs for students to represent cations and anions in a particular electrolyte. Each student should represent only one ion (e.g. Na^+ , Cl^- , H^+ and OH^- for NaCl solution).

Procedure: Students walk around the room. When you say go (representing the start of current flow), the students move to their respective electrodes (anions to anodes and cations to cathodes). Students (ions) lower in the electrochemical series must walk while those higher in the series run.

Theory: Many factors affect ion discharge at electrodes, one of which is order of preference in the electrochemical series. Products at the electrodes depend on the discharged ions. Those at the top of the series take preference and are discharged instead of the lower ions.

24.5.9 Electrolysis of Water

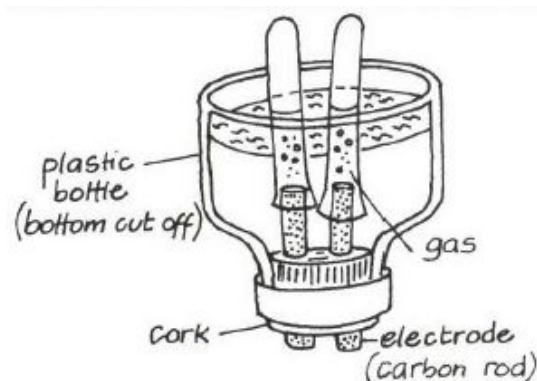

Materials: Bottle, clothes pegs, dry cells, 2 syringes, speaker wire, bulb, water, table salt

Setup: Remove 2 carbon electrodes from old dry cell batteries. Connect the electrodes and bulb in series with 3-4 dry cells.

Procedure: Fix the electrodes in a cork or bottle top (with super glue to seal). Place an overturned empty syringe tube over each electrode. Fill the container with a dilute sodium chloride solution by dissolving table salt in water. Close the circuit.

Observations: Bubbles at the electrodes indicate a reaction of electrolysis.

Theory: The cations present are H^+ from water and Na^+ from the sodium chloride. These migrate to the cathode, where the H^+ are discharged because hydrogen is lower than sodium in the reactivity series, and so *hydrogen gas is formed at the cathode*.

At the anode, OH^- ions from water are discharged in favor of Cl^- ions from salt, and so *oxygen gas is formed at the anode*.

The complete chemical equation for this reaction is:

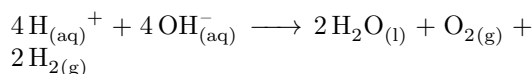

The volume of hydrogen gas produced is twice as large as that of oxygen.

24.5.10 Indicator Electrolysis

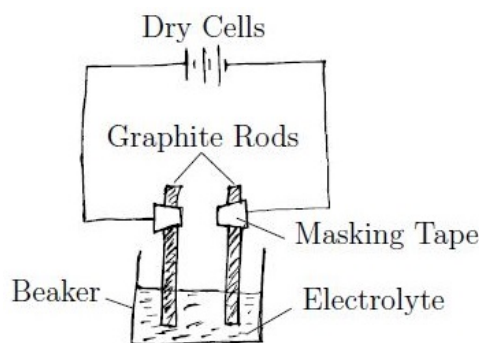

Materials: Clear bottle, phenolphthalein (PoP) indicator, water, salt, 4 dry cells (2 live, 2 dead) speaker wire

Setup: Strip the ends of the speaker wire. Carefully remove the carbon cores from the dead dry cells and wrap the stripped wires around the tops of them. In the container, make a saturated saline solution (keep dissolving salt until you can't dissolve anymore.) Add a few drops of POP indicator to the saline solution.

Procedure: Place the two carbon electrodes into the solution and attach them in series to the two remaining dry cells.

Hazards: Beware of battery acid from corroded batteries when removing the carbon cores. Additionally, in theory, the electrolytic cell will eventually produce dangerous chlorine gas (though this would require much time and a large setup).

Observations: The solution changes from transparent to a pink/purple colour as current continues to run through the solution. When the current is removed, the solution eventually returns to a colourless state.

Theory: As the current runs through the saline solution (electrolyte), the gases given off at the cathode and anode are hydrogen and oxygen respectively. While much of the hydrogen escapes as gas, some of the oxygen dissolves back in solution and causes it to become more basic (more OH^- ions exist compared to H^+ ions). As the solution becomes more basic, it turns to purple due to the presence of PoP. (PoP turns pink/purple in the presence of bases.) Upon the removal of current, the dissolved oxygen escapes as oxygen gas or rejoins with hydrogen ions to reform water, causing the solution to return to a neutral pH.

Notes: The purple colour originates at the anode. After connecting and reconnecting the circuit multiple times, the solution will remain more basic and the colour will not return to being transparent.

Application of Electrolysis

24.5.11 Electroplating

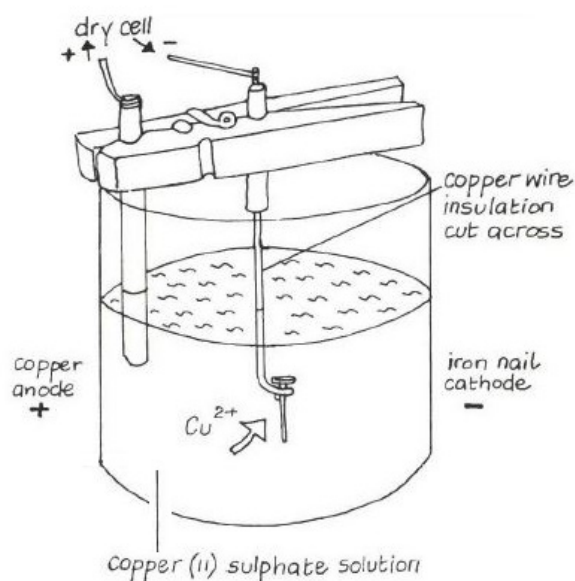

Materials: Dry cells, iron nail, copper wire, speaker wire, copper (II) sulphate, water, bottle

Setup: Strip or scrape the insulation from the copper wire as shown and connect to the nail. Connect this end to the *negative* terminal of the dry cell. To the positive terminal connect another stripped piece of copper wire. Place a copper (II) sulphate solution in the container.

Procedure: Submerge the nail and loose copper wire into the solution.

Observations: In a short time, the nail becomes pinkish as copper deposits on its surface. If left for a long time, the loose copper wire will disappear.

Theory: The copper metal (anode) oxidizes to form Cu^+ ions, which migrate towards the cathode (iron nail) where reduction takes place. The copper ions gain electrons to once again form copper metal on the surface of the nail.

Applications: Chrome plating of jewelry, etc. uses this process with chromium in place of copper. Galvanized nails are iron nails with zinc electroplated onto their surface to prevent rusting.

Notes: Use any conducting object in place of the nail, e.g. spoon, graphite electrode, etc.

24.6 Chemical Kinetics, Equilibrium and Energetics

Rate of Chemical Reactions

24.6.1 Effect of Temperature on Reaction Rate

Materials: 4 syringes, [Test Tube Racks](#), vinegar, baking soda, water [Heat Source](#)

Setup: Prepare a solution of sodium hydrogen carbonate (baking soda) by dissolving about 3 teaspoons per litre of water.

Procedure: Arrange 4 syringe test tubes in the rack and label them 1, 2, 3 and 4. Add about 3 mL of acid to tubes 1 and 2. Add 3 mL of base to tubes 3 and 4. Heat tubes 2 and 4 in the boiling water bath until they are near boiling. Pour tube 3 into tube 1, and pour tube 4 into tube 2.

Observations: The reaction between tubes 2 and 4 produces bubbles much faster than the reaction between tubes 1 and 3.

Theory: The rate of a chemical reaction increases with an increase in temperature.

24.6.2 Effect of Concentration on Reaction Rate

Materials: 3 bottles, 3 syringes, baking soda, vinegar, nail, super glue

Setup: Poke a hole through the lids of 3 bottles using a heated nail. Insert the tip of a 20 mL syringe in each and seal with super glue.

Procedure: Add 4, 2 and 1 teaspoons of baking soda to each of the 3 bottles respectively. Dilute each to 20 mL using water. Put 10 mL of vinegar in the first syringe, 5 mL in the second, and 2.5 mL in the third. Dilute each to 20 mL using water. Screw on each cap to its corresponding bottle and empty all 3 syringes at once.

Observations: As the reaction proceeds, the syringes are pushed upward. The first syringe is pushed up first, followed by the second and then the third.

Theory: The combination of baking soda (bicarbonate of soda) and vinegar produces carbon dioxide as a product, which pushes the syringe plunger upwards and fills the syringe. The higher the concentration of the reactants, the faster the reaction will proceed.

24.6.3 Effect of Surface Area on Reaction Rate

Materials: 2 syringes/bottles, dilute sulphuric acid, iron nail, iron wool

Procedure: Add small but equal amounts of dilute sulphuric acid to each container. In one, place an iron nail. In the other, place a piece of iron wool.

Hazards: Dilute sulphuric acid is corrosive to the skin and clothes and can cause damage to the eyes. Neutralize spills with baking soda.

Observations: Bubbles of hydrogen gas should be observed on the iron in both containers. The rate of bubble formation, however, should be much faster on the steel wool. After a minute, the difference in the rate of reaction should be observed.

Theory: The bubbles form much more quickly from the steel wool than from the iron nail because it has a much higher surface area.

24.6.4 Effect of a Catalyst on Reaction Rate

Materials: Old dry cell, hydrogen peroxide, 2 bottles, 2 balloons

Setup: Remove the dark powder (manganese dioxide) from an old dry cell.

Procedure: Add a small amount of hydrogen peroxide to each bottle. Add the manganese dioxide powder to one and then cover both bottles with balloons.

Observations: The balloon on the bottle containing manganese dioxide inflates, while the other does not.

Theory: Hydrogen peroxide decomposes very slowly at room temperature into water and oxygen gas. The manganese (IV) oxide from the battery *catalyzes* this reaction (speeds it up). Hence there is a notable change in the size of the balloon. The manganese (IV) oxide acts as a catalyst only by speeding up the reaction, not by increasing the amount of products formed.

Notes: The manganese dioxide does not get used up in this reaction. It can be dried and used again.

24.6.5 Organic and Inorganic Catalysts

Materials: Old dry cell, hydrogen peroxide, 4 syringes, water, yeast, Heat Source, 4 balloons

Setup: Remove the dark powder (manganese dioxide) from an old dry cell.

Procedure: Add 5 mL of water to each syringe and label them 1, 2, 3 and 4. Add yeast to tubes 1 and 2. Add manganese dioxide to tubes 3 and 4. Heat tubes 2 and 4 in a hot water bath until they boil. Add 5 mL of hydrogen peroxide to each tube simultaneously and quickly cap them with balloons.

Observations: Tube 4 inflates most quickly, while tube 2 does not inflate or does very little. Tubes 1 and 3 inflate at a slower rate.

Theory: Both catalase from yeast and manganese (IV) oxide from batteries act as catalysts. Catalase is a biological catalyst, while manganese (IV) oxide is not. Boiling the yeast in tube 2 destroys its catalase and hence slows down the reaction. Heating does not hinder the manganese dioxide, but in fact speeds up the reaction (tube 4). Tubes 1 and 3 still catalyze the reaction.

Applications:

Notes: Biological catalysts are subject to variations in the environment that kill or destroy biological activity.

Reversible and Irreversible Reactions

24.6.6 Reversible Chemical Reaction

Materials: Copper (II) sulphate, spoon, Heat Source, water

Setup: Grind the copper (II) sulphate crystals into powder.

Procedure: Add a small amount of copper (II) sulphate to a metal spoon and heat gently over the heat source. Stop heating when the crystals have changed from blue to white. Let the spoon cool, and add a couple drops of water to the white crystals.

Observations: The crystals regain their blue colour upon addition of water.

Theory: Heating the copper (II) sulphate changes it from blue ($\text{CuSO}_4 \cdot 5\text{H}_2\text{O}$) to white (CuSO_4). Adding water reverses this reaction and returns the crystals to their original hydrated state (blue).

Endothermic and Exothermic Reactions

24.6.7 Temperature Bottles



Materials: 3 plastic bottles, powdered soap, citric acid, spoon

Procedure: Add a small amount of water to each bottle. Add 3 spoons of powdered laundry soap (e.g. Omo, Foma) to the first bottle. Add 3 spoons of citric acid to the second bottle and nothing to the third bottle. Shake each vigorously and feel to observe any changes in temperature.

Theory: The dissolution of laundry soap in water is exothermic – this bottle should get warmer. The dissolution of citric acid is endothermic – this bottle should get cooler.

24.7 Extraction of Metals

Chemical Properties of Metals 24.7.3 Conductivity

24.7.1 Ductility

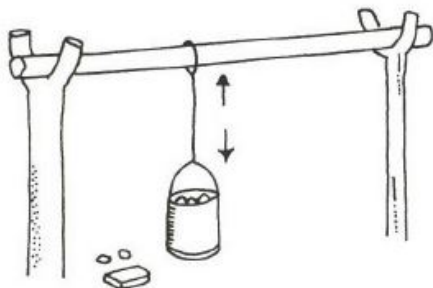

Materials: Supports, metal wire, weights

Procedure: Suspend the wire between supports and hang a weight onto the free end. One method is illustrated. Measure the length of the wire. Add weights and the wire will stretch.

Theory: The physical strength, or *tensile strength* of a metal is its ability to withstand applied force without breaking.

Notes: As an extension, compare the ductility of wires made from different metals.

24.7.2 Malleability



Materials: Aluminum can/roofing, hammer

Procedure: Hammer a crushed can, sheet of aluminium roofing, a zinc case of a dry cell or any available metal.

Observations: The metal spreads out.

Theory: When force is applied the metal ions in the giant metallic structure can move over each other like ball bearings and hence spread out.

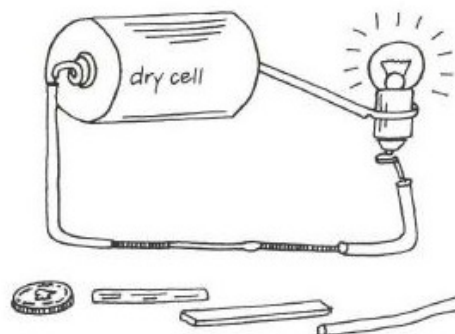

Materials: Dry cell, wires, bulb, metals (e.g. nail, zinc plate, copper wire, etc.), various items (e.g. graphite, pen, pencil, etc.)

Procedure: Set up the circuit as shown. Try various metals and non-metals to see which ones complete the circuit and light the bulb.

Observations: Metals light the bulb.

Theory: Metals contain a "sea of electrons" which are mobile. When these are made to flow in a conductor with the aid of a battery an electrical current flows and the bulb is lit. Non-metal structures do not in general have this sea of electrons except carbon in the form of graphite, which has delocalised, mobile electrons between the layers of carbon atoms.

24.8 Compounds of Metals

Metal Oxides

24.8.1 Direct Preparation of a Metal Oxide

Materials: Copper wire, [Heat Source](#), spoon

Setup: Clean the copper wire by scraping or burning off the insulation.

Procedure: Heat the copper wire strongly over a flame and observe any changes.

Observations: Copper metal reacts with air to form black copper (II) oxide.

Notes: This experiment can also be tried with zinc metal, which turns yellow when heated strongly in air. The yellow colour turns white when allowed to cool. This product which is yellow when hot and white when cold is zinc oxide (ZnO).

24.8.2 Indirect Preparation of a Metal Oxide

Materials: Zinc metal, battery acid (5 M sulphuric acid), bottle, washing soda (sodium carbonate), cloth, [Heat Source](#), spoon

Setup: Prepare a solution of sodium carbonate by dissolving two tablespoons in about 500 mL of water. Remove the zinc plate from an old dry cell.

Procedure: Put about 10 mL of sulphuric acid (battery acid) into a beaker. Add a small piece of zinc metal and allow it to dissolve. After the zinc has completely dissolved, add about 10 mL of sodium carbonate solution. Allow the precipitate to settle and then filter and collect it on the metal spoon. Heat the sample strongly on the spoon until a colour change is noted.

Observations: The precipitate changes from white to yellow when heated.

Theory: When zinc reacts with dilute sulphuric acid, a soluble zinc sulphate salt forms by displacement reaction. When sodium carbonate is added, zinc carbonate precipitate is formed (ZnCO_3). ZnCO_3 is white in colour. When heated, the gas CO_2 is evolved and the residue is ZnO. The ZnO is yellow when hot and white when cold.

Metal Hydroxides

24.8.3 Preparation of Metal Hydroxides

Materials: Steel wool, battery acid (5 M sulphuric acid), caustic soda (sodium hydroxide), cloth, funnel, bottles

Setup: Prepare a sodium hydroxide solution by adding 1 spoon of sodium hydroxide to 100 mL of water.

Procedure: Add a small amount of steel wool to one container. Add about 10 mL of battery acid, adding more steel wool until all of the acid is consumed. Note the colour of the solution.

When the reaction is finished, decant the contents of the bottle into a container of sodium hydroxide. A precipitate should form immediately. Observe the colour of the precipitate. Pour the mixture with the precipitate into the filter funnel. Leave to filter. Observe any change in colour. Once most of the liquid has passed through the filter, remove the solid from the filter funnel and leave to dry.

Theory: The steel wool reacts with sulphuric acid to form iron (II) sulphate. This solution reacts with sodium hydroxide solution to produce a green, gelatinous precipitate of iron (II) hydroxide. On exposure to air, this precipitate oxidizes to reddish brown iron (III) hydroxide.

Carbonates and Hydrogen-Carbonates

24.8.4 Preparation of Copper Carbonate

Materials: Epsom salt (magnesium sulphate) and/or copper (II) sulphate, washing soda (sodium carbonate), funnel, cotton wool, beakers, spoons

Setup: Stuff cotton wool into the funnel to plug the hole at the bottom.

Procedure: In one beaker, add 2 spoons of magnesium sulphate or 1 spoon of copper sulphate to about 100 mL of water and stir until dissolved. In a second beaker, add 2 spoons of sodium carbonate to about 100 mL of water and stir until dissolved.

Add the sodium carbonate solution to the magnesium sulphate / copper sulphate solution. A precipitate should form immediately.

Filter the precipitate and allow it to dry.

Theory: When magnesium sulphate solution is mixed with sodium carbonate solution, magnesium carbonate precipitates. When copper sulphate solution is mixed with sodium carbonate solution, copper carbonate precipitates. This demonstrates the preparation of metal carbonates by precipitation reactions.

24.8.5 Preparation of Calcium Carbonate



Materials: Straw, lime water, bottle, test tube

Procedure: Add some lime water to a bottle or syringe. Blow into the solution through a straw.

Observations: The solution turns a milky white colour.

Theory: Carbon dioxide blown from the straw will react with lime water $\text{Ca}(\text{OH})_2$ to form a white precipitate of CaCO_3 . This shows that carbon dioxide reacts with an alkali solution.

Metal Sulphates

24.8.6 Preparation of Zinc Sulphate

Materials: Zinc metal, dilute sulphuric acid, bottles, evaporating dish, Heat Source, steel wool

Setup: Clean a zinc plate from an old dry cell using steel wool and cut it into small pieces.

Procedure: Add zinc pieces to a bottle followed by dilute sulphuric acid. After all the zinc has reacted, heat the solution on an evaporating plate until crystals are visible and collect the remains.

Theory: Zinc reacts with the sulphuric acid and replaces hydrogen gas and form soluble zinc sulphate. The product formed from the evaporation of the zinc sulphate solution is the white solid zinc sulphate.

Chemistry Activities for Form IV

25.1 Non-Metals and Their Compounds

Chlorine

25.1.1 Preparation of Chlorine Gas

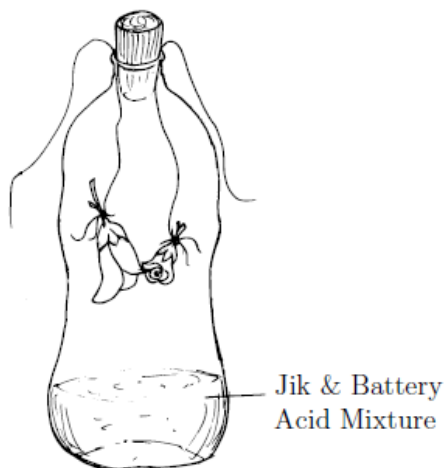

Materials: Bleach, battery acid (5 M sulphuric acid), coloured flowers, string or thread, bottle

Setup: Collect coloured flowers. 2. Cut about 30 cm of string for each flower and tie one to each flower.

Procedure: Put about 100 ml of bleach (e.g. Jik) in the bottle. Hang the flowers in the bottle using the strings. Tie the free end of the string around the neck of the bottle. Add about 10 ml of battery acid to the bottle and quickly close the cap. Allow the bottle to sit for 5 minutes.

Hazards: This reaction produces chlorine, a poisonous gas. Perform this reaction outside standing upwind. No students should attempt to prepare chlorine outside of school.

Observations: The gas turns a greenish-yellow colour.

Theory: The chlorine gas will bleach the flowers in the bottle. The bleaching action is due to the formation of hypochlorite ion, formed when chlorine dissolves in water:

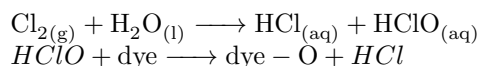

Sulphur

25.1.2 Model of Sulphur S_8

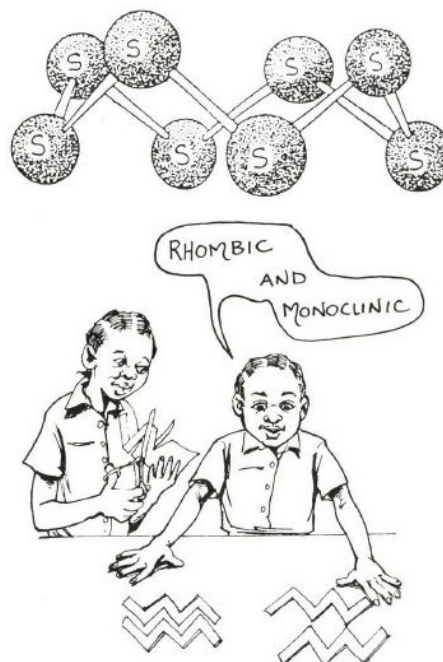

Materials: Fruits/modeling clay/ugali, tooth-picks

Procedure: (a) Use berries, fruits, modeling clay spheres, balls of ugali, etc. for the sulphur atoms and sticks for the bonds. Construct the model as shown in the above diagram.

(b) The S_8 molecule can be simplified as a crown shape which can be cut of cardboard. This can be used to show how the rings are packed in rhombic and monoclinic sulphur.

Theory: In rhombic sulphur the rings are interlocked as shown in the diagram above. This is a stable arrangement at room temperature. In monoclinic sulphur the rings are stacked (see diagram), this is a less stable arrangement explaining why monoclinic sulphur is the least stable allotrope at room temperature.

25.1.3 Monoclinic and Rhombic Sulphur

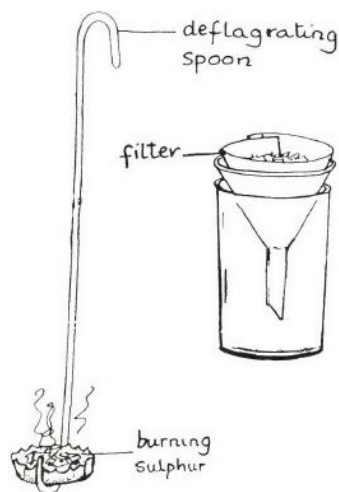

Materials: Powdered sulphur, bottle cap, candle, paper funnel, deflagrating spoon, bottle

Procedure: Put 3-4 spatulas of powdered sulphur into a bottle top. Heat very gently until it is just melted or plasticised. Pour the molten sulphur, which should be a clear yellow liquid, into a filter paper funnel. Leave to cool until a crust just forms on the surface of the sulphur. Break open the surface to expose the crystals underneath.

Hazards: Sulphur can catch fire to produce noxious fumes of sulphur dioxide.

Observations: Thin needle-like crystals of monoclinic sulphur are seen.

Theory: Sulphur has two allotropes, rhombic and monoclinic sulphur. Rhombic sulphur is the more stable form. The transition temperature between the two is 96°C . Since sulphur melts at 116°C , melting and allowing it to cool slightly exceeds the transition temperature and monoclinic sulphur is formed. It will revert to its more stable form, rhombic sulphur, in a few days time.

25.1.4 Reaction of Sulphur with Metals

Materials: Sulphur powder, copper wire, two spoons, Heat Source, scissors, match box

Procedure: Cut the copper wire into small pieces and place a few onto a spoon. Add a small amount of sulphur and mix (there should be more sulphur than copper). Heat the mixture over a flame until it turns black.

Hazards: This reaction produces sulphur dioxide, a poisonous gas. Perform outside or in a well-ventilated room and stand upwind.

Theory: Copper and sulphur react to form black copper (II) sulphide.

Sulphur Dioxide

25.1.5 Production of Sulphur Dioxide Gas

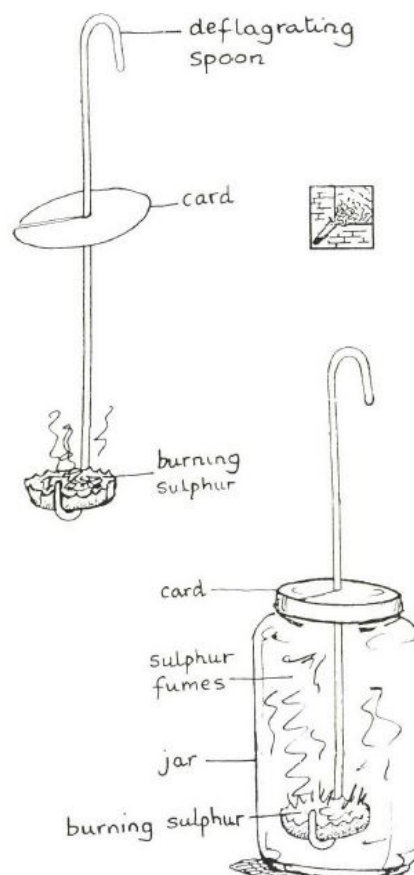

Materials: Cardboard or manila, deflagrating spoon, sulphur, bottle cap, jar, candle

Procedure: Cut out a circle of stiff paper or cardboard and fix it onto the deflagrating spoon as shown in the diagram. Put 2-3 spatulas of sulphur into a bottle top and heat it in a flame until the sulphur catches fire. Immediately transfer the deflagrating spoon into a glass jar.

Hazards: Sulphur dioxide fumes are noxious, thus experiment should be done in a well-ventilated room, near an open window or in a fume chamber.

Observations: The sulphur burns with a blue flame. Choking fumes of gas are produced.

Theory: Sulphur burns in air to form choking fumes of sulphur dioxide gas.

25.1.6 Sulphuric Acid

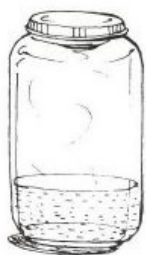

Materials: Jar of sulphur dioxide gas, indicator, water

Procedure: Add water to the jar of sulphur dioxide gas and then add some indicator.

Observations: The gas dissolves and the solution is acidic (the universal indicator paper turns red).

Theory: Sulphur dioxide gas is very soluble in water. It forms an acidic solution called sulphuric (IV) acid.

Applications: This is the principle on which acid rain is formed.

25.1.7 Bleaching Effects of Sulphur Dioxide



Materials: Jar of sulphur dioxide gas, newspaper

Procedure: To a jar of sulphur dioxide gas add a small piece of a newspaper. Firmly replace the lid of the jar.

Hazards: This reaction produces sulphur dioxide, a poisonous gas. Perform this reaction outside or in a well-ventilated room and stand upwind.

Observations: The newspaper is bleached.

Theory: Sulphur dioxide gas is a bleaching agent. This experiment works well when the sulphur dioxide gas is in high concentration.

Nitrogen

25.1.8 Sources of Nitrogen



Procedure: Make a display (or prepare wall charts) of

- food rich in proteins, e.g. fish, meat;
- nitrogen fertilizers;
- soldering stone (NH_4Cl) as used by welders.

All plants contain a certain amount of protein, but some have a high concentration, particularly seeds like cow pea, groundnut and soya bean.

25.1.9 Preparation of Nitrogen Gas

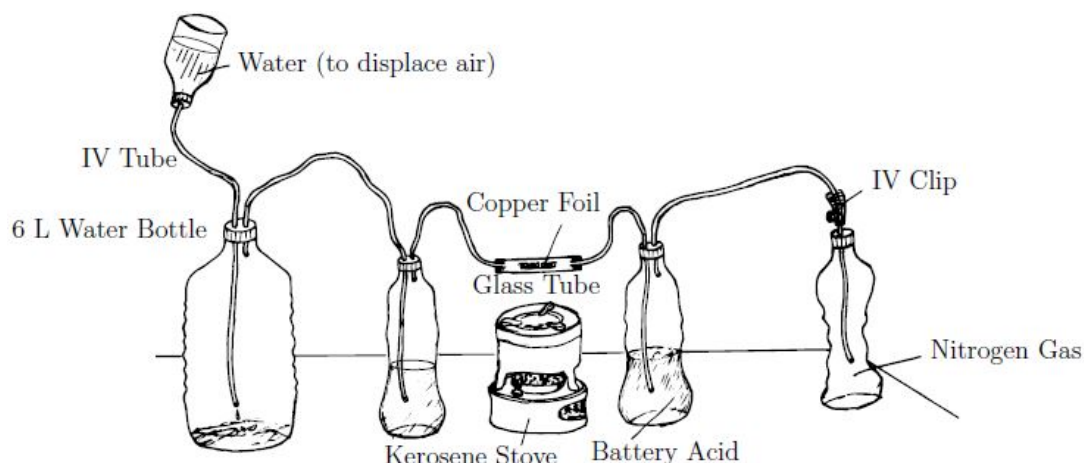

Materials: Large water bottle (6 L), caustic soda (sodium hydroxide), battery acid (5 M sulphuric acid), delivery tubes, Heat Source, piece of glass tube (about 20 cm), 4 empty water bottles (1 or 1.5 L), very thin copper wire

Setup: Poke 2 holes in each of 2 bottle tops; in the third top poke 1 hole. Connect the delivery tubes in these holes using pen tubes as junctions. Insert the copper turnings inside the glass tube. Prepare a 2 M solution of caustic soda in a 1 L bottle with two holes in the cap. Put sulphuric acid in the other bottle with two holes in the cap. Arrange the apparatus set up as in the figure making sure that the last bottle is squeezed (compressed) to remove air before collection.

Procedure: Add water through the funnel into the 6 L bottle so as to displace air present in the bottle. This is done after the copper turning starts to be red hot. Observe what happens in the two water bottles A and B as well as the changes of the red hot copper turning in the combustion tube. Observe the expansion of the bottle C as water fills the 6 L bottle. Collect the gas in the bottle C by tightening the delivery tube.

Hazards: Sodium hydroxide (caustic soda) is corrosive to the skin and even in a dilute solution can blind. Avoid contact with skin and eyes. Neutralize spills with citric acid solution. Concentrated sulphuric acid is corrosive to the skin and clothes. Avoid contact with skin and eyes. Neutralize spills with bicarbonate of sodium (baking soda).

Observations: Copper turnings turn red hot when heated in the absence of air (i.e. before water is added to the 6 L bottle). After the addition of water to 6 L bottle, bubbles will be observed in both A and B and the red hot copper turnings turn black.

Theory: The collection bottle (C) should expand. The black colour of copper indicates oxidation of copper by atmospheric oxygen. Copper oxide is black. The bubbles observed in the bottles indicates the passage of air into the solution.

25.1.10 Nitrogen Oxides from Lightning



Theory: During thunderstorms, lightning heats the air locally to a very high temperature. Thus nitrogen and oxygen from the air react to form nitrogen oxides. Some of these are converted by further reaction with rain water to nitric acid which in the soil forms nitrates. The latter are nitrogen fertilizers. Hence, if the pollutants from vehicles are absent, thunderstorms contribute to the fertilization of fields in this way.

25.1.11 Nitrogen Circulation

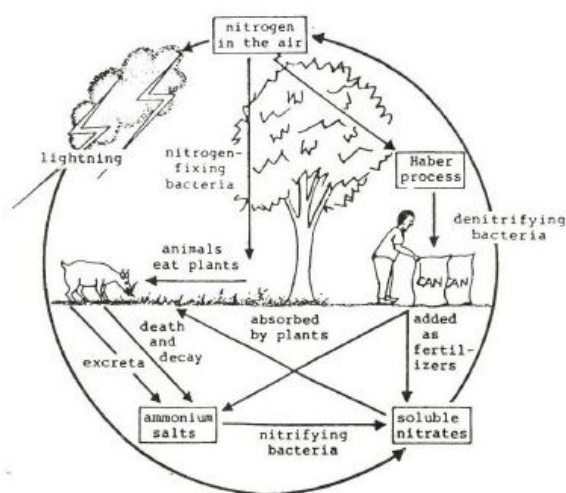

Materials: Cards/manila, flip chart

Procedure: Prepare a wall chart of the natural nitrogen circulation or make cards of the various steps for students to place.

Theory: When proteins are broken down in the body, combined nitrogen containing compounds leave the body with the urine. These compounds are broken down further by bacteria to ammonia (NH_4) which makes for example public places of urination smell very badly. Dead plant and animal tissues are similarly broken down. The ammonia formed is washed into the soil, where it is acted upon by different types of bacteria, eventually converting it into nitrates and ammonium salts which are needed by plants to produce proteins. Hence they are important fertilizers.

Ammonia

25.1.12 Preparation of Ammonia Gas



Materials: Ammonium sulphate, caustic soda (sodium hydroxide), red litmus paper, match box, conc. HCl (optional), [Heat Source](#), heating vessel

Setup: Prepare sodium hydroxide solution by dissolving approximately 1 spoon of sodium hydroxide in about 200 mL of water.

Procedure: Put one tea spoon of ammonium sulphate into a heating vessel. Add about 100 mL of sodium hydroxide solution to the ammonium sulphate and mix. Warm the mixture using a heat source. Test the gas evolved using moist red litmus paper. Record observations and note the smell of the gas.

Optional: Bring a bottle containing conc. HCl acid, open it and allow fumes coming out of the bottle to react with the gas evolved from the gas generator.

Observations: Ammonia is a colourless gas with pungent smell (smell of urine), it turns red litmus blue. It also forms white fumes when it comes into contact with HCl vapors.

Theory: Ammonia gas is the only alkaline gas known, it reacts with hydrogen chloride gas to form thick/dense white fumes of ammonium chloride (This is the identification of the gas). It is highly soluble in water, which is why it can't be collected over water. It is less dense than air that is why it is collected by downward displacement of air (upward delivery).

Carbon Dioxide

25.1.13 Production of Carbon Dioxide Gas

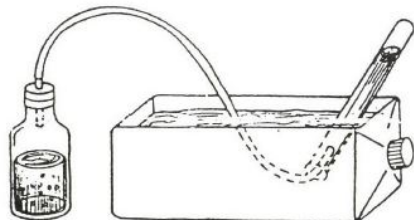

Materials: Plastic bottle, plastic tube, syringe, wood ash, dilute acid (e.g. citric acid)

Procedure: Assemble the apparatus as shown. Put a spoonful of ash into the bottle, add some dilute acid and close the bottle immediately. The syringe fills with gas.

Theory: The potassium carbonate in wood ash reacts with dilute acid to produce carbon dioxide gas.

25.1.14 CO₂ Balloon

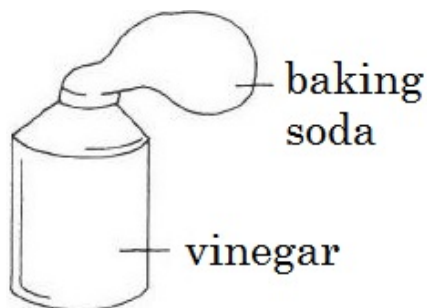

Materials: Bottle, baking soda, vinegar, balloon

Procedure: Add a small amount of vinegar into a bottle. Fill a balloon with baking soda (bicarbonate of soda) and stretch the balloon over the mouth of the bottle. Lift the balloon to empty the contents into the bottle.

Observations: The balloon fills up with gas and may even explode!

Theory: The vinegar and baking soda combine to produce carbon dioxide gas, which gets collected in the balloon.

Applications: Employ the scientific method by varying the concentrations of vinegar and baking soda to see the effect on the amount of CO₂ gas released.

25.1.15 Test for Carbon Dioxide



Materials: Bottle, lime water, straw

Procedure: Pour some lime water into a bottle and blow (with a straw or a tube) bubbles of air into lime water. It will take some time until you can observe a change.

Observations: The lime water becomes cloudy, proving the presence of carbon dioxide in our exhaled air.

25.1.16 CO₂ in Soda

Materials: Unopened soda bottle

Procedure: (a) Open the soda bottle and watch how long it takes to stop releasing carbon dioxide (when bubbles stop forming). (b) Repeat but first shake the soda bottle before opening. (c) Repeat again but add salt after the initial carbon dioxide has escaped.

Observations: The soda in part (b) is sprayed out of the bottle at a high pressure. In part (c), adding salt helps to remove the remaining carbon dioxide in the soda.

Theory: When soda is bottled, CO₂ gas is pumped in at high pressure, and some of it dissolves in the soda. Removing the top allows this pressurized gas to escape, although some of the CO₂ remains attracted to water molecules. This is why carbonation remains for some time after opening.

Shaking the bottle causes previously escaped CO₂ to redissolve in the soda and form large bubbles which rush to the surface to escape the solution.

Water has a greater attraction to the salt molecules than the CO₂ molecules, so adding salt causes the water to release the CO₂ molecules and push them together. They combine and form larger bubbles, which rise to the surface of the soda.

25.2 Organic Chemistry

Introduction to Organic Chemistry

25.2.1 Showing the Presence of Carbon in Sugar

Materials: Metal spoon, sugar, candle

Procedure: Place the spoon above the flame of the candle.

Hazards: Be sure to use caution when using the flame as the spoon can get hot.

Observations: As the cap heats up it will heat the sugar. Heating the sugar will partially burn it before turning completely to carbon and carbon dioxide. This partial combustion is visible - as the sugar burns it turns brown and then black.

Theory: As sugar burns in air, it partially combusts, leaving behind carbon solid and other carbon compounds before changing into carbon dioxide. These carbon compounds have a brown color and the carbon solid compounds have a black color. As the sugar heats, it will combust until having a brown color, then to a black color. This black substance is solid carbon.

Applications: This is the same color as charcoal, which is another example of solid carbon. The browning of the sugar is called caramelization. As the sugar breaks down into smaller and different saccharides, they bring a very delicious taste. This is the process that is used very much in making different candies, especially toffees, brittles, and caramels. In fact, this is how many candies get their brown or dark color.

25.2.2 Converting Soaps into Lipids or Fats

Materials: Powdered soap, battery acid, water, jam jar

Procedure: Take half of a spoon of powdered soap and dilute it to about 50 mL in a jam jar. Add about 2 mL of battery acid.

Hazards: Handle battery acid with care.

Observations: Bubbles of oil will form on the surface of the water.

Theory: Soaps are actually long chains of hydrocarbons with a protonated carboxylic acid group on the end. This protonated group allows soaps to cause oil and water to mix: it is both hydrophobic on one end and hydrophilic on the other. One end can dissolve in water

while the other ends dissolves in the oil layer. This allows soap to be soluble in both water and oil solutions.

Applications: This is why soaps are used to clean off grease, oil, and other organic solvents. The organic solvents are hydrophobic and the soap can dissolve them.

25.2.3 Cracking Household Oil

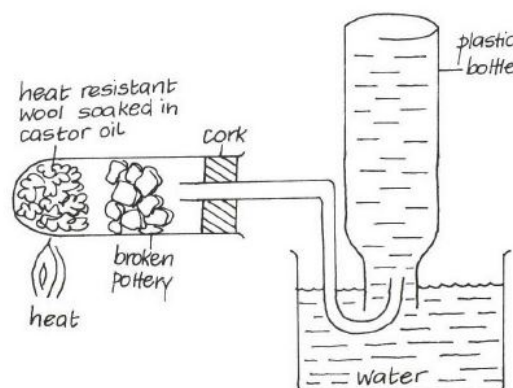

Materials: Test tube/syringe, steel wool, two burners, oil, bottle, water

Setup: Take a narrow test tube and place it at an angle. At the bottom, place some normal household oil. At the top, stuff in some steel wool so it does not move. Seal the tube with cork or a rubber stopper.

Procedure: Heat the steel wool until very hot. Then place a second burner under the oil so both the oil and the wool are being heated. After a minute or two, take a flame to the end of the tube.

Hazards: Handle flame with caution and be aware that gases produced are flammable.

Observations: The gases escaping the tube can sustain a flame.

Theory: *Cracking* is a process where long hydrocarbon chains are heated so they are broken into smaller chains of molecules. Household oil is a triglyceride: a compound that has a glycerin backbone that has 3 long hydrocarbon arms. These long hydrocarbons range between 15 and 30 carbons long. These hydrocarbon arms can be broken easily by heating them in the presence of a catalyst, iron wool in this case. As they break down into smaller hydrocarbons, they become more volatile and combust easily. The long hydrocarbons will break down into hydrocarbon chains of 3 to 8 carbons. These will burn in air supporting a flame at the end of the tube.

25.2.4 Petroleum Products

Materials: syringe with needle, 3 jam jars, as many as possible of: petrol, diesel, car lubricants, greases, petroleum jelly, kerosene, asphalt, tar, butane from a lighter

Setup: Place some petrol, kerosene, diesel, and any other petroleum product in different jam jars. For butane use a syringe to remove the butane from a lighter. There is usually a small hole where a needle can be inserted to add more butane gas.

Procedure: Compare the different properties of each of these compounds.

Hazards: Many petroleum products are quite flammable. Additionally the butane of a lighter is under pressure.

Questions: How do the density, viscosity, volatility, and flammability of the petroleum products compare and contrast?

Theory: We use many petroleum products every day. Crude oil is a black thick mixture of different hydrocarbons. To get different petroleum products, the crude oil is cracked and distilled to separate compounds depending on the number of carbon atoms. Butane is an early distillate since it has 4 carbons it distills easily. Petrol is an 8 carbon distillate. Kerosene has 12 to 15 carbons. Diesel has 15 to 25 carbons. Petroleum jelly is not a small hydrocarbon, but rather very long chains of varying length that does not distill easily. It is one of the last products from distilling crude oil.

Notes: If you want to make some mock crude oil to show students, mix road tar with kerosene until you have a viscous liquid.

25.2.5 Preparation of Soap

Materials: Sunflower oil, caustic soda (sodium hydroxide), distilled water, salt, bottle, filter papers, [Heat Source](#), beaker

Setup: Prepare a 1 M solution of sodium hydroxide and a concentrated salt water solution.

Procedure: Put about 25 mL of sunflower oil into an empty jar or bottle. Add about 100 mL of 1 M sodium hydroxide solution. Light the heat source and heat the mixture gently for 30 minutes so that the content mixes. Continue heating and stirring while adding distilled water from time to time until no more solids separate out. Allow the mixture to cool and then add brine (concentrated NaCl solution). Stir the mixture continuously for 5 minutes. Pour the solution into a fresh beaker and allow it to settle. The solution should solidify. Use a small piece of the solid soap to clean an oily piece of cloth.

Hazards: Sodium hydroxide (caustic soda) is corrosive to the skin and even in a dilute solution can blind. Avoid contact with skin and eyes. Neutralize spills with citric acid solution.

Questions: What is the chemical formula for soap formation? How could you prepare soap at home?

Theory: The soap is produced when sodium salt of fatty acid is produced from the reaction of vegetable oil with caustic soda. The soap cleans an oily piece of cloth.

Applications: The soap produced is sodium salt of fatty acid and is similar to the ordinary soap we buy in the market/shops.

25.2.6 Acting Out Polymerisation

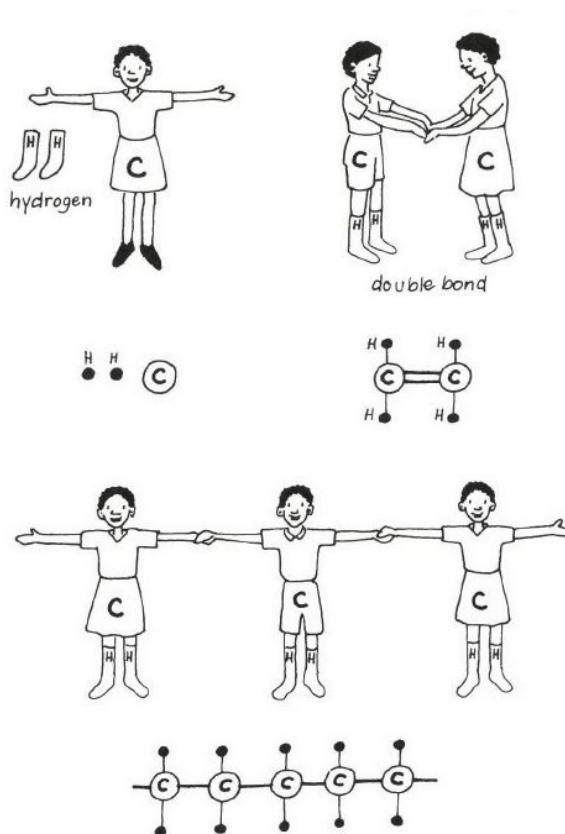

Materials: Socks, students

Procedure: Students act out polymerisation of molecules by having a shirt or skirt represent carbon atoms and socks representing hydrogen atoms. Arms represent single or double bonds.

Theory: The small molecule is ethene which polymerises to poly(ethene) - often called polythene.

25.2.7 Organic Chemistry Naming Game

Materials: Cardboard/styrofoam/any material which a toothpick can stick in, toothpicks, markers, deck of cards

Setup: Cut cardboard into small equal size pieces (at least 50) and label roughly a third of them "C", a few with "O", and the rest with "H". Write out on a piece of paper:

Diamond ("Kisu") - Alkane
Spade ("Jembe") - Alkene
Heart ("Moyo") - Alkyne
Club ("Maua") - Carboxylic Acid/Alcohol

K - Propyl Substituent
Q - Ethyl Substituent
J - Methyl Substituent

A - 1 Carbon atom
2 - 2 Carbon atoms
3 - 3 Carbon atoms
4 - 4 Carbon atoms
5 - 5 Carbon atoms
6 - 6 Carbon atom
7 - 7 Carbon atoms
8 - 8 Carbon atoms
9 - 9 Carbon atoms
10 - 10 Carbon atoms

Procedure: Draw a card from the deck and create a model of the organic molecule using the cardboard (Carbon, Hydrogen, and Oxygen atoms) and toothpicks (bonds) based on the card they receive. For example, a 3 of hearts would require the student to construct a three carbon alkyne molecule (propyne).

If a face card is drawn the student would draw another card and use the face card as a *substituent* to add on to the molecule. (Ex: A player draws a queen and then takes another card which turns out to be a 7 of spades. The student must make a model of a 7 carbon alkene molecule (heptene) and add a ethyl substituent (due to the queen). In all cases the student must name the compound - here ethylheptene.) Points can be attributed to the complexity of molecules created and competitions can be made.

Applications: Being able to understand the name and structure of organic chemicals is an important part of organic chemistry, and this game allows students to practice constructing structures and names for all the types of organic molecules that are learned in the O-level syllabus.

Hydrocarbons

25.2.8 Alkanes

Materials: Butane lighter, petrol, kerosene, Vaseline, candle wax, pin/syringe needle.

Setup: Place each of the items (butane lighter, petrol, kerosene, Vaseline, and candle wax) on a desk in this order. (Use the needle to press the release valve on the underside of the butane lighter.) Write approximate chemical formulas for each compound. Butane is C_4H_{10} ; petrol is C_8H_{18} , kerosene is about $C_{12}H_{26}$, Vaseline is about $C_{20}H_{42}$, and wax is about $C_{25}H_{52}$. Note that these are only approximate formulas, especially for the larger molecules.

Procedure: Observe the visible properties of each alkane sample. Comment on the states of matter of each. Rank them from smallest molecules to largest. Note the correlation between molecule size and state of matter.

Questions: Which substances have the strongest attraction between molecules? Which have the weakest? What is the connection between attraction of molecules and boiling point/melting point? What is the connection between attraction of molecules and the size of hydrocarbon molecules? Why is butane a liquid inside the lighter and a gas outside?

Observations: Larger hydrocarbons tend to be solids while smaller hydrocarbons tend to be liquids. The smallest hydrocarbons (methane, ethane, propane, and butane) are gases at room temperature and atmospheric pressure.

Theory: The only forces of attraction between molecules of hydrocarbons are van der Waals forces or London dispersion forces. The strength of these forces increases with the size of the molecules. Therefore substances made from large hydrocarbon molecules (e.g. wax) have stronger intermolecular forces than those made from small hydrocarbon molecules (e.g. butane). The stronger the intermolecular forces, the greater thermal energy must be present to shake the molecules apart from each other, i.e. to cause melting and boiling.

Applications: Butane is a gas at room temperature and atmospheric pressure. Butane lighters hold the butane under pressure to force the molecules together to form a liquid. This allows for more efficient storage of the butane. When the valve on the lighter is pressed, butane can exit the lighter where it vapourizes under the reduced pressure.

25.2.9 Parent Chains

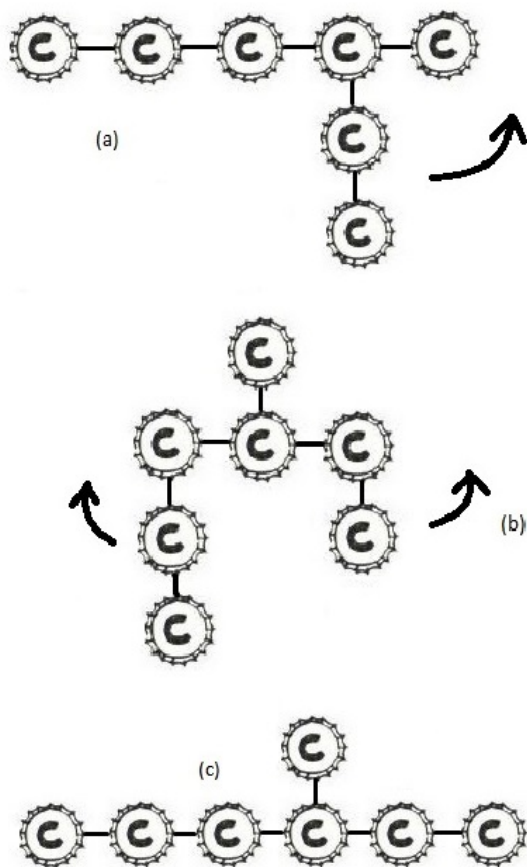

Materials: Bottle caps, malleable wire (e.g. copper wire), tape

Setup: Tape bottle caps to a strip of wire as shown in a or b (at least 3 in a single line).

Procedure: Have students find and count the longest chain of bottle caps (carbon atoms) and write the name of the compound. Then bend the wire to show the actual longest chain (parent chain).

Observations: Many students assume that any horizontal chain (a or b) is the parent chain. This is not always the case. Images a, b, and c are the exact same organic molecule, but c shows the correct parent chain has 6 carbons.

Theory: The parent chain of hydrocarbons is determined by counting the longest continuous chain of carbons. This is the arrangement in which the locant (or sum of locants) is lowest. Students often forget that the parent chain is not always in a straight line.

25.2.10 Candles as Hydrocarbons

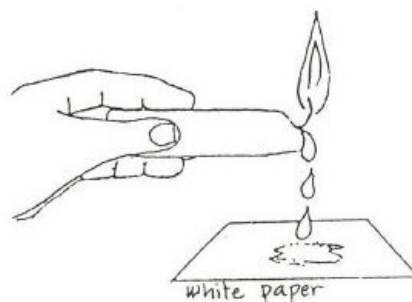

Materials: Candle, paper

Procedure: Drop some liquid candle wax on a clean white piece of paper.

Questions: What happens to the paper? Why?

Observations: Candle wax produces a greasy not on paper.

Theory: Candle wax is chemically related to grease fats and oils, it consists of long chain hydrocarbons.

Alcohols

25.2.11 Preparation of Ethanol by Fermentation of Sugar

Materials: Gas generator, spatula, yeast, sugar, lime water, test tube

Procedure: Put 10-20 mL of lime water in a test tube and put the open end of the delivery tube from the gas generator into this solution. Make a sugar solution (3 spoonfuls sugar, 100 mL water). Add about 1 $\frac{1}{2}$ teaspoons of yeast and seal the bottle. Label the container and set it aside, checking daily for changes in the lime water.

Observations: When yeast is added to the sugar solution and left for some time, carbon dioxide is generated, which turns the lime water cloudy. The solution remaining in the bottle will have a faint smell of alcohol which shows the presence of ethanol.

Theory: Ethanol may be produced directly from petroleum, but for human consumption it is prepared by the fermentation of carbohydrates. Fermentation is the chemical breakdown of a substance by bacteria, yeasts, or other micro-organisms. Yeast breaks down sugar into alcohol and carbon dioxide gas.

Applications: Fermentation of starch or sugar produces many common alcoholic beverages, e.g. beer and wines.

25.2.12 Reaction of Ethanol with Oxygen

Materials: Colourless spirit, match box, soda cap with plastic removed, knife

Procedure: Put approximately 1 mL of ethanol into a soda cap. Light a match and touch it to the ethanol.

Hazards: Ethanol is flammable and the flame is hot. This activity should not be done on or around plastic or cloth material. Advise students that the flame may be colourless, thus special care must be taken. An ethanol flame can be extinguished with water if needed.

Questions: What happens when alcohol is lit with a match? What is the balanced chemical equation for the combustion of ethanol?

Observations: When the lit match is brought to the flame the ethanol burns in the presence of oxygen. A colourless flame will form.

Theory: One property of alcohols is that they readily combust. Ethanol burns readily in air with an almost colourless flame, producing carbon dioxide and water. The balanced chemical equation for this reaction is:

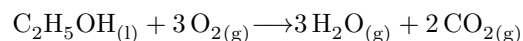

Carboxylic Acids

25.2.13 Reaction of Alcohol and Carboxylic Acid

Materials: Citric acid powder, methylated spirits, battery acid (5 M sulphuric acid), 2 beakers, tea spoon

Setup: Make a saturated solution of citric acid by mixing citric acid powder and clean water in a water bottle and shaking it until powder is dissolved.

Procedure: Put citric acid solution into one of the beakers. Take a small amount of the citric acid solution (about three water caps full) and pour it in the second beaker. Into the second beaker add about one cap full of battery acid and mix. To the mixture above add about three caps full of spirit and mix. Observe the smell.

Hazards: Battery acid is 5 M sulphuric acid. Concentrated sulphuric acid is corrosive to the skin and clothes. Avoid contact with skin and eyes. Neutralize spills with bicarbonate of sodium (baking soda).

Questions: Why was battery acid added to the citric acid solution? What smell did you detect in your experiment? Can you tell what the product is? What is the chemical reaction equation assuming that the spirit contains only ethanol?

Observations: Spirit reacts like ethanol and reacted with citric acid in the presence of acidic medium to produce an ester with fragrant smell.

Theory: One organic reaction of major importance is esterification. Esterification is the formation of an ester (ROOR') group through the reaction of an alcohol and a carboxylic acid. Many esters are volatile and their production can be observed by smell.

25.3 Soil Chemistry

Soil Formation

25.3.1 Soil Formation

Materials: Dilute sulphuric acid, calcium carbonate rock (coral, limestone, marble) or egg shells, beaker

Procedure: Place carbonate rock or egg shells in a beaker. Add dilute sulphuric acid and observe.

Observations: Bubbles of carbon dioxide should be observed where acid touches the rock. This shows that the acid is chemically reacting with the rock. Over time, the surface of the rock should also look corroded, more evidence of chemical weathering.

Theory: Soils are made by physical and chemical weathering of rocks. Chemical weathering is caused by the action of acids on carbonate rocks. These acids may be organic acids produced by soil organisms or carbonic acid from the dissolution of atmospheric carbon dioxide in water:

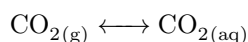

and then

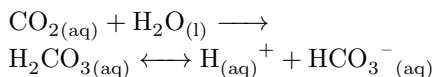

These acids react differently with different kinds of rocks. In the case of limestone, marble, coral, and other rocks made mostly from calcium carbonate, the reaction is:

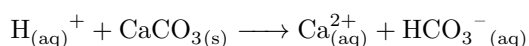

Note that the result is a solution of calcium hydrogen carbonate. This is the source of hard water. Chemical weathering is a slow process. This activity speeds up the process by using dilute sulphuric acid so that students may more quickly see the result. Because sulphuric acid is a strong acid, it will also react with the hydrogen carbonate:

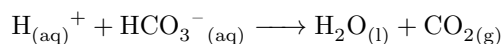

The carbon dioxide thus produced can be observed as small bubbles forming on the surface of the rock. Note that in real chemical weathering, carbon dioxide is generally not produced, and instead the reaction stops with a solution of calcium hydrogen carbonate.

Notes: Rocks with more complicated chemical composition are also subject to chemical weathering.

25.3.2 Cement Making and Erosion

Materials: Cement, sand, water, plastic water bottles, large plastic container

Setup: Add equal volumes of cement and sand to a large plastic container or wheelbarrow (the actual volume used is not important). Add water to make a paste and pour off into a plastic water bottle with the top cut off. This bottle acts as a mold for the cement. Then, add a second volume of sand to the large plastic container. Pour into a plastic water bottle. Add a third volume of sand, and then pour into a water bottle. Repeat this procedure until you have added 12 volumes of sand. Let the cement dry overnight and cut off the plastic water bottle. Label and keep each different sample of cement.

Procedure: Take the cement pieces and place them outside to bear the elements. Record their status each week.

Theory: The ratio of cement to sand decreases through each dilution. This means that the strength that holds the cement together decreases as the ratio of cement to sand increases. We can see this by leaving the different pieces of cement outside to erode. The strongest pieces will resist erosion the most. Those that have a 1:10 ratio of cement to sand will erode very easily.

Applications: This is why most cement blocks look like they are melting when it rains. The cement is too diluted to resist erosion effectively. Over the course of a year, the cement that has a 1:10 or 1:12 ratio will erode while the other pieces of cement will not erode.

Soil Nutrients

25.3.3 Leaching

Materials: Sand, solid food colouring, filter funnel, beaker, water

Setup: Prepare a mixture of sand and solid food colouring.

Procedure: Emphasize that the food colouring represents soluble minerals and soil nutrients. Place the sand mixture in a filter funnel placed over a beaker. Add water and observe the colour of the filtrate.

Observations: The filtrate takes on the colour of the sand that it passes through.

Theory: Chemicals present can often pass through the soil as water makes its way through the soil and end up in water sources.

Soil Reaction

25.3.4 Measuring Soil pH

Materials: Various soil samples, rosella leaves, paper, bottles, water

Setup: Prepare an indicator solution or litmus paper by adding rosella leaves to hot water and dipping thin strips of paper into the solution.

Procedure: Put soil in a bottle. Add water to the soil and stir. Test the liquid with indicating paper. Record any changes.

Theory: Some soils are neutral in pH. Others are acidic or basic, depending on the composition of the soil. This activity is meant to demonstrate the existence of acidic and basic soils.

Notes: Traditionally, this activity is performed with universal indicator. However, exceptionally acidic or basic soils should be possible to detect using red and blue indicating paper, which may be locally made.

25.3.5 Raising Soil pH by Liming

Materials: An acidic soil (as determined from above activity), lime (cement or calcium hydroxide), water, indicator paper

Procedure: Add lime to an acidic soil sample. Test again with indicator paper.

Theory: The addition of lime will cause the soil to become more basic, and thus have a higher pH.

25.3.6 Lowering Soil pH with Ammonium Sulphate

Materials: A basic soil (as determined from above activity), ammonium sulphate fertilizer, water, indicating paper

Procedure: Add ammonium sulphate to a basic soil sample from the soil pH activity. Test again with indicator paper.

Theory: The addition of ammonium phosphate will cause the soil to become more acidic, and thus have a lower pH.

25.4 Pollution

25.4.1 Pollution and Chemistry



Procedure: Divide the class into small groups. Think of some daily situations where pollution is seen in air, water or soil. Write them out on cards and give one to each group of students. One by one, have a group read the situation and then ask the class what kind of pollution is present and what suggestions they can give on how to reduce pollution in that situation.

Terrestrial Pollution

25.4.2 Trash Journal

Procedure: Have each student record in a journal all of the trash that they make every day for 2 weeks. If possible, collect the trash and weigh it every day.

Observations:

Theory: Trash is a big problem in large towns and cities. Many manufactured goods come with a lot of waste material, which accumulates over time. Many waste items can be *recycled*, or reused for different purposes.

Questions: What are some methods for eliminating waste? What effect does burning trash have on the environment?

25.4.3 Biodegradable Waste

Materials: Shovel/jembe, Banana peel, plastic bottle, rubber bands, paper

Procedure: Dig several small holes and place a different item in each, covering them with dirt. Check back on the items after several weeks, months, and after a year.

Observations: The banana peel shrivels and degrades after a couple weeks, while the other items remain for many months or even years.

Theory: Banana peels are an example of organic waste. They are *biodegradable*, meaning that it breaks down in the environment. *Non-biodegradable* waste does not break down, it just piles up.

Applications: Do not throw plastic bottles out of the window on buses!!

25.4.4 Planting Trees



Procedure: Planting trees and protecting newly planted trees from animals is one way for community members to look out for the well-being of their environment and maintain and beautify their homes and schools.

Theory: Trees consume excess carbon dioxide, which is a harmful greenhouse gas that eats away at our ozone layer. They produce the oxygen that we breathe and help to maintain a balanced ecosystem for other organisms.

Applications: Many individuals cut down trees for firewood but fail to replace them with newly planted trees. Over time this can lead to erosion and degradation of the land.

Water Pollution

25.4.5 Water Purity Surveys



Procedure: Keeping a record of water purity and health in a local community is a great way to raise awareness about environmental protection. Students can test for hardness of water, pH, or other impurities and harmful bacteria present in water samples.

Questions: What are some other ways that you can get involved in protecting the environment?

25.4.6 Acid Rain



Applications: Pollution (e.g. from factories and cars) is carried in the wind and eventually lowers the pH of the water droplets in the air. Eventually the water returns to the ground as acid rain. The acid rain may fall a long way from the cause of the pollution - often in a different country.

Air Pollution

25.4.7 Smog



Observations: On sunny days, nitrogen oxides react with other pollutants of the air to form smog. You may be able to observe smog on sunny days over large cities if you look from a tall building or a mountain.

Theory: Everywhere combustion at high temperature takes place in air, nitrogen from the air reacts with oxygen to form various nitrogen oxides. They are present in the exhaust from cars, lorries and buses, in the smoke of burning charcoal etc. Smog damages the lungs of people, especially children and old people, and the tissues of plants.

Global Warming

25.4.8 Greenhouse Bucket

Materials: Buckets, black paint/shoe polish, sheet of glass, water

Procedure: Get two dark coloured buckets or paint them black on the outside. Fill them with water and place them out in the sun on a hot day. Place a sheet of glass over the top of one of the buckets. At the end of the day feel the water in the two buckets.

Observations: The bucket with the glass sheet covering will be warmer.

Theory: The glass allows light rays to enter through it, but reflects some of its energy back into the bucket as it tries to escape. Hence the light and heat are trapped inside the bucket and the water temperature increases.

Applications: When the sun heats the surface of the earth it sends back heat radiation into the atmosphere. Carbon dioxide and the other greenhouse gases form a blanket which does not allow the radiant heat to escape. Thus the temperature of the atmosphere is gradually increasing making the earth warmer.

Materials and Equipment

Local Materials List

In order to gain a thorough understanding of science, students must be able to make a connection between classroom learning and the outside world. The following is a list of locally available materials which may be used to substitute conventional materials and apparatus for various activities. These materials have the following advantages:

- They are readily available in the village or a nearby town;
- They are cheaper than conventional materials;
- They may safely substitute the conventional materials without fear of losing accuracy or understanding;
- They help students to draw a connection between science education and the world around them.

Imagination and innovativeness is encouraged on the part of the student and teacher to find other suitable local substitutions.

Below are common apparatus you might order from a laboratory supply company, and comments about which have good if not superior alternatives available in villages and towns. Given equal quality, it is generally better to use local materials, because these help connect classroom learning to students' lives.

The apparatus listed in this section are the following:

- | | | |
|-----------------------|------------------------|------------------------------|
| 1. Balance | 17. Gloves | 33. Slides and Cover Slips |
| 2. Beakers | 18. Goggles | 34. Spatula |
| 3. Blowpipe | 19. Heat Source | 35. Stoppers |
| 4. Bulbs | 20. Indicator | 36. Stopwatches |
| 5. Bunsen Burner | 21. Iron Filings | 37. Test Tubes |
| 6. Burettes | 22. Masses | 38. Test Tube Brush |
| 7. Crucible | 23. Measuring Cylinder | 39. Test Tube Holder / Tongs |
| 8. Containers | 24. Metre Rule | 40. Test Tube Racks |
| 9. Deflagrating Spoon | 25. Microscope | 41. Tripod Stands |
| 10. Delivery Tube | 26. Mortar and Pestle | 42. Volumetric "Glass"ware |
| 11. Droppers | 27. Nichrome Wire | 43. Wash Bottle |
| 12. Electrodes | 28. Optical Pins | 44. Water Bath |
| 13. Electrode Holders | 29. Pipettes | 45. Weights |
| 14. Filter Paper | 30. Retort Stand | 46. White Tiles |
| 15. Flasks | 31. Scale Pans | 47. Wire |
| 16. Funnel | 32. Scalpels | 48. Wire Gauze |

How many experiments can be carried out with everyday items?

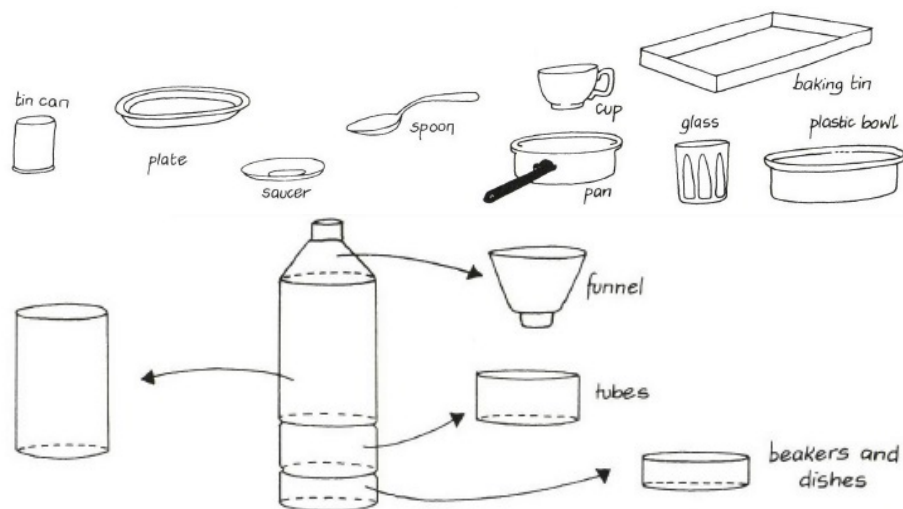

26.1 Balance

Use: Measuring mass

Materials: Ruler or wooden bar 30 cm × 2 cm, nails, razor/knife, string/wire, pen, 2 [Scale Pans](#)

Procedure: Find the balancing point of the ruler/wood block and mark it with a pen. Use a heated nail to make a hole through this point. Make notches at 5 cm intervals on either side of the center hole using a razor/knife to suspend scale pans. Use a string/wire tied through the center hole to suspend the balance.

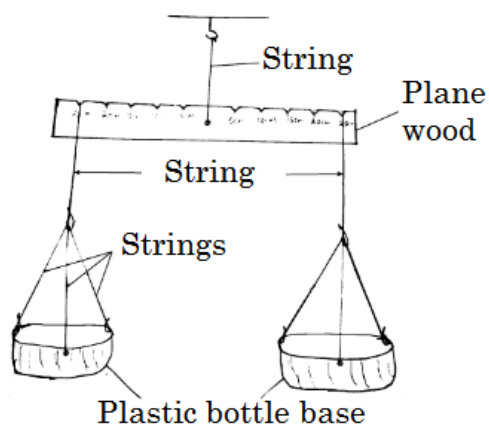
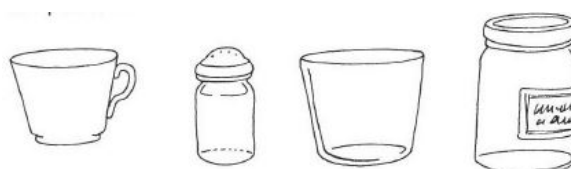

26.2 Beakers

Use: To hold liquids, to heat liquids

Materials: Water bottles, jam jars, metal cans, knife/razor

Procedure: Take empty plastic bottles of different sizes. Cut them in half. The base can be used as a beaker. Jam jars made of glass, cut off metal cans and aluminum pots may be used when heating.

Safety: Glass containers may shatter if heated too much. Use standard laboratory equipment if extreme heating is needed.

26.3 Blowpipe

Use: Increasing temperature of flames

Materials: Syringe needle, tube/straw/pen tube

Procedure: For sterilisation heat the needle in open fire for a longer time before using it. A drinking straw or a clean plastic tube can be used as a connection to the mouth.

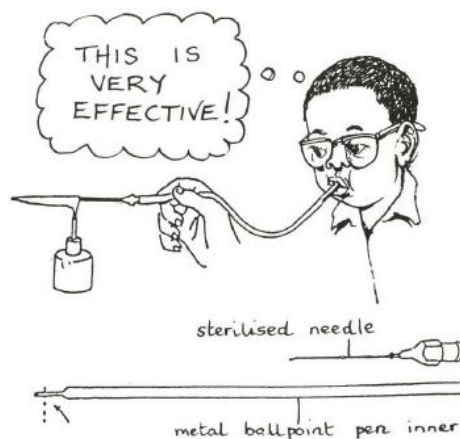

26.4 Bulbs

Use: Electrical circuits, diodes

Materials: Broken phone chargers, flashlights, other electronic devices

Procedure: Look for LEDs from broken items at hardware stores, local technicians, or small shops.

26.5 Bunsen Burner

See [Heat Source](#) (p. 136).

26.6 Burettes

Use: Titration

26.6.1 Version 1

Materials: 10 mL syringes

Procedure: Use 10 mL disposable plastic syringes with 0.2 mL gradations. Students can estimate between the lines to at least 0.05 mL. If you must buy, buy plastic.

26.6.2 Version 2

Materials: Syringe, IV giving set, super glue, knife

Procedure: Cut off the part of the IV tube with the flow control slider. Remove the plunger from the syringe and use superglue to attach the tube to the nozzle of the syringe.

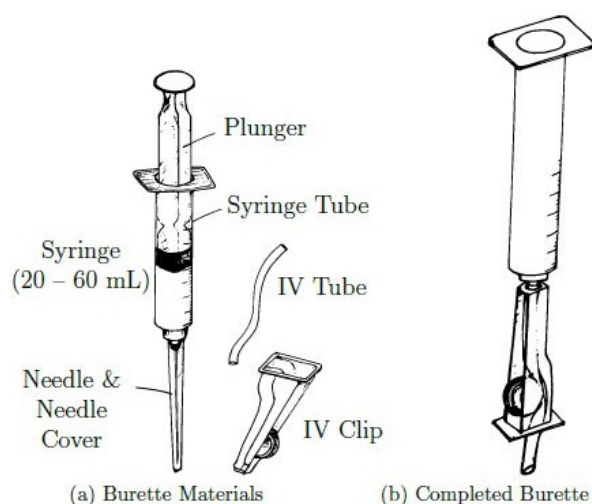

26.7 Containers

Use: Measuring large volumes (100 mL – 2 L) of solution, titration, storage

Materials: Plastic water bottles, jars, tin cans

Procedure: Identify the volume of useful marks on the bottles and combine to measure accurate volumes.

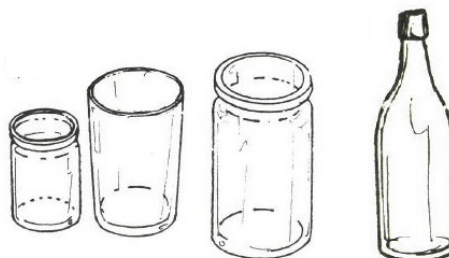

26.8 Crucible

Use: Heating substances at very high temperatures

Materials: 2 metal spoons, wire

Procedure: Place the material in one spoon and then wire 2 spoons together.



26.9 Deflagrating Spoon

Use: For heating chemicals to observe melting, decomposition, or other changes on heating

Materials: Metal spoons, galvanised wire, soda bottle cap

Procedure: Bend 30 cm of galvanised wire as shown. The wire should hold the bottle cap firmly.

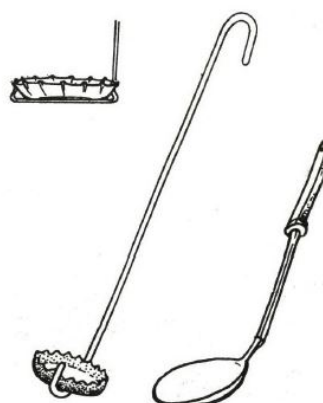

26.10 Delivery Tube

Use: Movement and collection of gases, capillary tubes, hydraulic press

Materials: Straws, pen tubes, IV tubing (giving sets) from a pharmacy, bicycle tubing

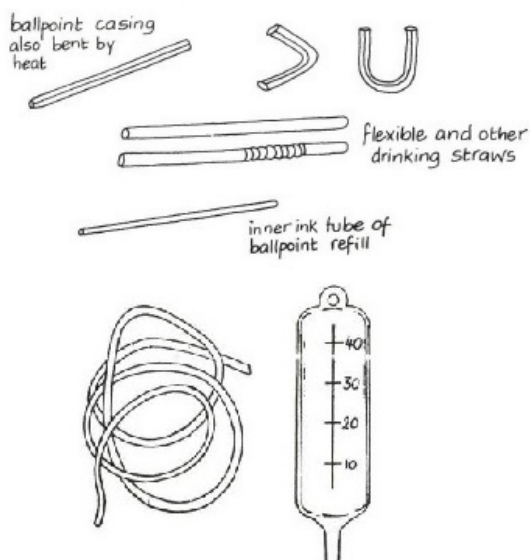

26.11 Droppers

Use: To transfer small amounts of liquid

Materials: 2 mL syringes, straws

Procedure: Take a syringe. Remove the needle to use as a dropper. Or insert a straw into a liquid and then plug the free end with a finger to remove a small amount and use as a dropper.

26.12 Electrodes

Use: Electrolysis

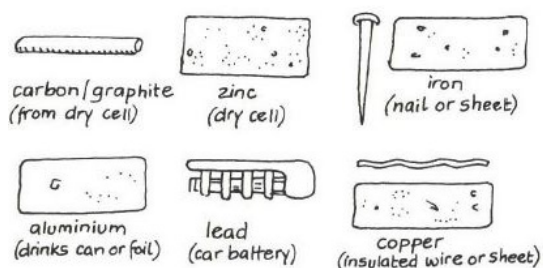

26.12.1 Graphite

Materials: Old dry cell batteries

Procedure: Gently smash an old battery (D size) with a rock and pull out the electrode with pliers. DO NOT do this with alkaline batteries (most AA size) as they contain caustic liquids.

26.12.2 Zinc

Materials: New dry cell batteries

Procedure: Carefully open up a NEW dry cell (D size) battery by peeling back the steel shell and slicing the plastic inside. You should find a cylindrical shell of zinc metal. Empty out the black powder inside (manganese dioxide mixed with zinc chloride and ammonium chloride; wash your hands after) and keep the graphite electrode for another day. The zinc shell should then be cut into strips, scraped clean, and boiled in water or washed with soap to remove any residual chemicals that might affect your experiment.

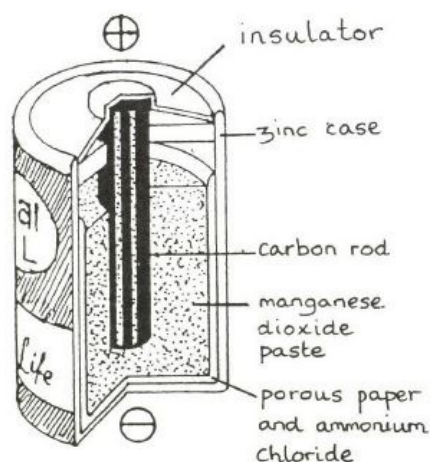

26.12.3 Iron

Materials: Ungalvanized nails from a hardware store

26.12.4 Copper

Materials: Thick wire stripped of its insulation, also from a hardware store. Note that copper earthing rods have only a thin surface layer of copper these days.

26.13 Electrode Holders

Use: Electrolysis

Materials: Clothes pins

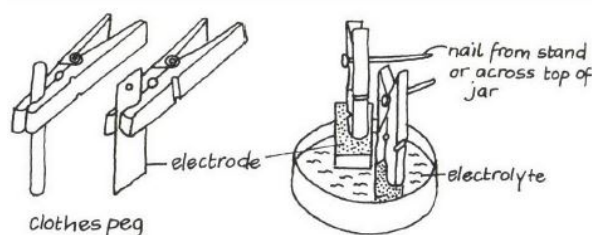

26.14 Filter Paper

Use: Filtration, separating mixtures, solutions

Materials: Cement bag paper, toilet paper, cloth

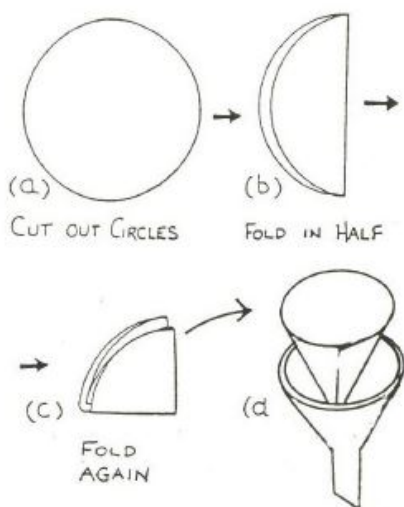

26.15 Flasks

Use: Titrations, mixing solutions

Materials: Clean used liquor bottles, small water bottles

Procedure: When using these flasks for titrations, students must practice swirling enough that the solution remains well mixed.

Safety: When heating glass liquor bottles, make sure the cap is off.

26.16 Funnel

Use: To guide liquid or powder into a small opening

Materials: Empty water bottles, knife

Procedure: Take an empty water bottle and remove the cap. Cut it in half. The upper part of the bottle can be used as a funnel.

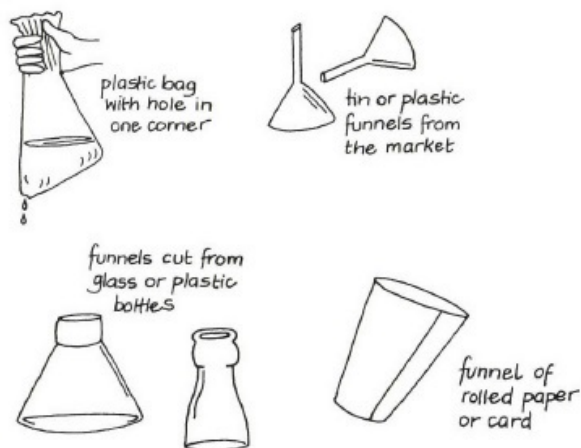

26.17 Gloves

26.17.1 Latex gloves

Use: First aid, when one has open cuts on hands, handling specimens. They are worthless to the chemist because they make the hands less agile and give the user a false sense of security.

Safety: Concentrated acids and organic chemicals burn straight through latex.

26.17.2 Thick gloves

Use: For working with organic solvents. Remember that the most dangerous organic solvents (benzene, carbon tetrachloride) should never be used in a school, with or without gloves.

Materials: Thick rubber gloves from village industry supply companies and some hardware stores

Safety: In general, avoid using chemicals that would make you want to wear gloves.

26.18 Goggles

Use: Handling concentrated acids

Materials: 1.5 L plastic water bottles, cardboard, sunglasses

Procedure: Cut a strip of plastic from a water bottle. Attach around your head with string or by using stiff cardboard as a frame. Goggles do not need to be impact resistant – they just need to stand between hazardous chemicals and your eyes.



26.19 Heat Source

Use: Heating substances

Materials: Candles, kerosene stoves, charcoal burners, Motopoa (alcohol infused heavy oil), butane lighters, spirit burners, metal can, bottle caps. Motopoa provides the best compromise heat source - it is the easiest to use and safest heat source with locally available burners.

Procedure: Cut a metal can in half or use a bottle cap and add a small amount of Motopoa.

Safety: Always have available fire-fighting equipment that you know how to use. Remember that to put out a Bunsen burner safely, you need to turn off the gas.

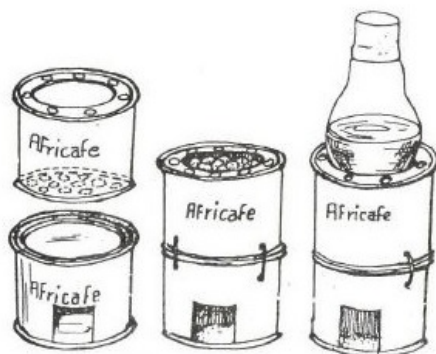
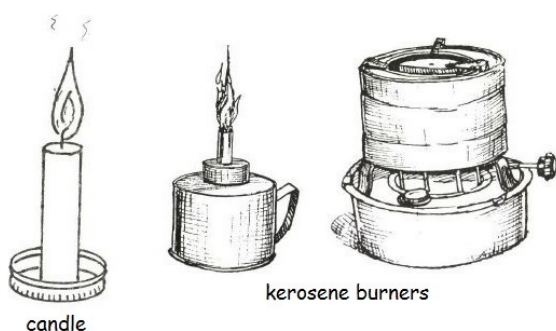

charcoal burner

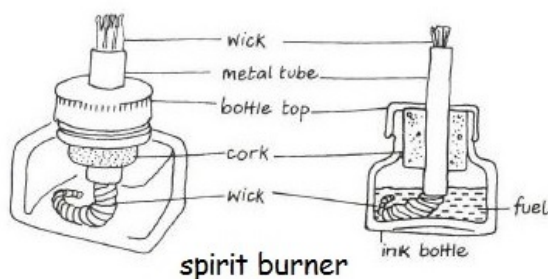

spirit burner

26.19.1 Heating Solutions

The ideal heat source has a high heat rate (Joules transferred per second), little smoke, and cheap fuel, i.e. Motopoa. A charcoal stove satisfies all of these but takes time to light and requires relatively frequent re-fueling. Kerosene stoves have excellent heat rates but are smoky.

26.19.2 Heating Solids

The ideal heat source has a high temperature and no smoke, i.e. a Bunsen burner. For heating small objects for a short time (no more than 10-20 seconds), a butane lighter provides a very high temperature. Motopoa will provide a flame of satisfactory temperature for as long as necessary.

26.19.3 Flame Tests

The ideal heat source has a high temperature and produces a non-luminous flame, i.e. a Bunsen burner. Motopoa is next best hot and non-luminous. Spirit burners produce a non-luminous flame at much greater cost, unless methylated spirits are used as fuel in which case the flame is much cooler. A butane lighter produces a very hot flame of sufficient size and time for flame tests although the non-luminous region is small. Kerosene stoves will work for some salts.

26.20 Indicator

Use: Determine presence of acid or base, determine pH

Materials: Rosella leaves, hot water, bottle

Procedure: Place some coloured leaves into a bottle of warm water to extract the colour. Use a straw to drop onto solutions or prepare indicator paper by dipping thin strips into the coloured solution. Rosella turns red for acids and greenish blue for bases.



26.21 Iron Filings

Use: To map magnetic fields

Materials: Steel wool / Iron wool used for cleaning pots

Procedure: Rub some steel wool between your thumb and fingers. The small pieces that fall are iron filings. Collect them in a matchbox or other container to use again.

26.22 Masses

See [Weights](#) (p. 140).

26.23 Measuring Cylinder

Use: Measuring volume

Materials: Plastic bottles of different sizes, syringes (10 mL - 50 mL), fluorescent light tubes, marker pen, ruler, bucket of water

Procedure: Using the syringe, transfer a known volume of water from the bucket to the empty bottle. Use the marker pen to mark the level of water on the bottle. Repeat for a range of volumes, using a ruler to complete the scale.

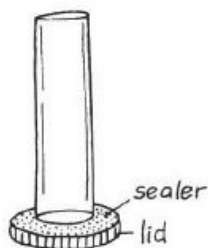

26.24 Metre Rule

Use: Measuring length

Materials: Slabs of wood, ceiling board, permanent pen

Procedure: Buy one, take it and a permanent pen to a carpenter, and leave with twenty. Measure each new one to the original rule to prevent compounding errors.

26.25 Microscope

See [Low Tech Microscopy](#) (p. 141).

26.26 Mortar and Pestle

Use: To powder chemicals

Materials: 2 metal spoons, glass bottle

Procedure: Place chemicals between two nested metal spoons and grind down. Alternatively, crush chemicals on a sheet of paper by pressing on them with the bottom of a glass bottle.



26.27 Nichrome Wire

For flame tests in chemistry, you can use a steel wire thoroughly scraped clean with iron or steel wool.

26.28 Optical Pins

Use: Compass needles, making holes, dissection, mirror practicals

Materials: Office pins, sewing needles, needles from syringes

26.29 Pipettes

Use: Transferring small amounts of liquid

Materials: Disposable plastic syringes (1, 2, 5, 10, 20, 25, 30 and 50 mL sizes)

Procedure: Suck first 1 mL of air and then put the syringe into the solution to suck up the liquid. There should be a flat meniscus under the layer of air.

Safety: Avoid standard pipettes to eliminate danger of mouth pipetting.

26.30 Retort Stand

Use: To hold springs, burettes, pendulums or other objects

Materials: Filled 1.5 L water bottle, straight bamboo stick, tape, marker

Procedure: Tape the bamboo stick across the top of the water bottle so that it reaches out 20 cm to one side. Attach a small clamp if required or hang the object directly from the bamboo stick.

Alternatively, place a 1 cm piece of reinforcing rod in a paint can full of wet cement and let it dry. Then attach a boss head and clamp.

26.31 Scale Pans

Use: Beam balance

Materials: Plastic bottle, cardboard box, string

Procedure: Cut off the bottom of a plastic bottle or cardboard box. Poke 3 or more holes near the top and tie string through each hole. Join strings and tie at the top to hang from a single point.

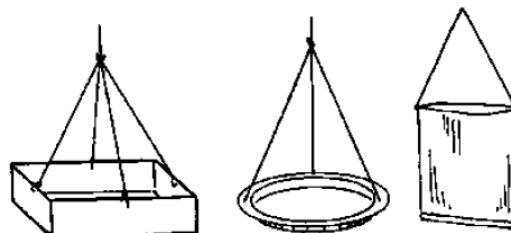

26.32 Scalpels

Use: Dissection

Materials: Razor blades, tongue depressors, super glue

Procedure: Add a handle by gluing a tongue depressor on either side of the razor blade. Hold together with a rubber band until dry.

Safety: Dull blades should be discarded. Because students need to apply more pressure when using them, there is a greater risk of slipping and thus of cuts. Sharp tools are much safer.

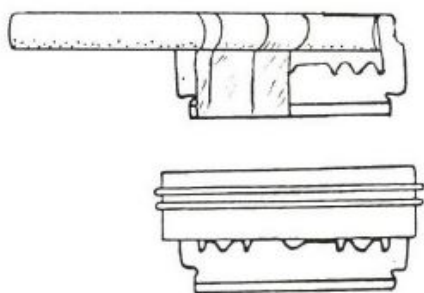

26.33 Slides and Cover Slips

Use: Microscopy

Materials: Small pieces of glass, stiff plastic

Procedure: Small piece of glass provides a slide for mounting the specimen. Cover slips can be made from thin (but stiff) transparent plastic from display packing or bottles. Cut into small squares or circles.

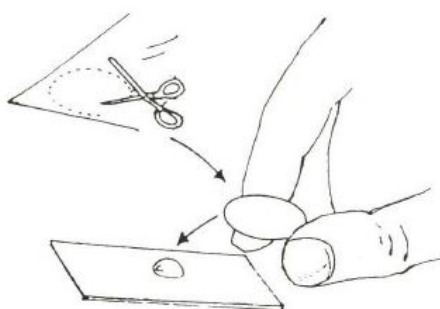

26.34 Spatula

Use: Transferring salts

Materials: Stainless steel spoons

Procedure: Use the handle end to remove salts from containers.

Safety: Clean all metal tools promptly after using with hydroxide, potassium manganate (VII), or manganese (IV) oxide. If the spoon corrodes, scrape with another spoon or steel wool.

26.35 Stoppers

Use: To cover the mouth of a bottle, hold a capillary tube

Materials: Rubber from old tires or sandals, cork, plastic bottle cap, pen tube, super glue

Procedure: Cut a circular piece of rubber. If the stopper is being used to hold a capillary tube, a hole can be melted in a plastic cap or rubber stopper. Alternatively, super glue a pen tube to a plastic bottle cap and connect to rubber tubing.



26.36 Stopwatches

Use: Simple pendulum, velocity, acceleration

Materials: Athletic and laboratory stopwatches from markets, digital wristwatches

26.37 Test Tubes

26.37.1 Plastic Test Tubes

Use: To heat materials without a direct flame, to combine solutions

Materials: 10 mL syringes, matches

Procedure: Remove the needle and plunger from 10 mL syringes. Heat the end of the shell with a match until it melts. Press the molten end against a flat surface (like the end of the plunger) to fuse it closed. If the tube leaks, fuse it again. Test tubes made this way may be heated in a water bath up to boiling, hot enough for most experiments.

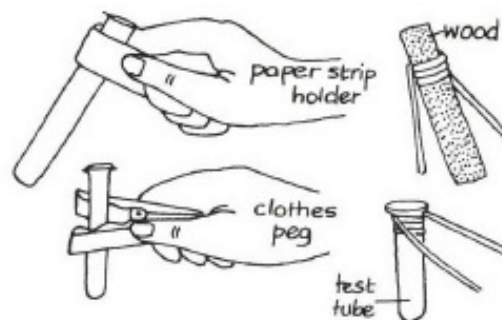

26.37.2 For Thermal Decomposition

See [Deflagrating Spoon](#) (p. 133).

26.38 Test Tube Brush

Use: Cleaning test tubes

Materials: Sisal, wire

Procedure: Twist the wire around the sisal as shown or put a little sand in the test tube as an abrasive.

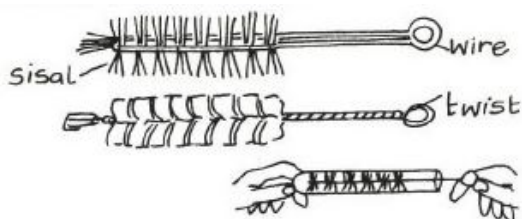

26.39 Test Tube Holder / Tongs

Use: To handle test tubes

Materials: Wooden clothespins, stiff wire, strip of paper or cloth

Procedure: Use clothespins or stiff wire for prolonged heating, or strips of paper or cloth for short-term heating.

26.40 Test Tube Racks

Use: To hold test tubes vertically in place

Materials: Wire grid from local gardening store, styrofoam block, plastic bottle, sand, knife

Procedure: Fold a sheet of wire grid to make a table; punch holes in a piece of styrofoam; cut a plastic bottle in half and fill it with sand to increase stability. Or cut a plastic bottle along its vertical axis and rest the two cut edges on a flat surface. Cut holes into it for the test tubes.

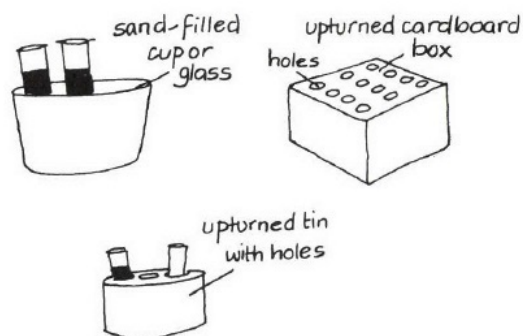

26.41 Tripod Stands

Use: For supporting containers above heat sources, for elevating items

Materials: Stiff wire, metal rods, tin can

Procedure: Join bent pieces of thick wire together. Or cut the sides of a tin can to leave 3 legs.

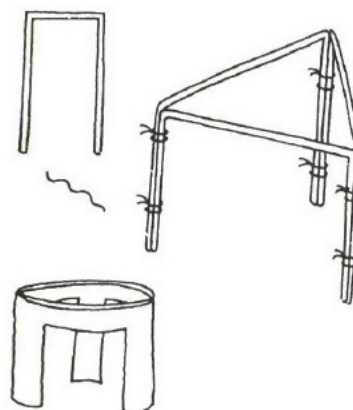

26.42 Volumetric “Glass”ware

See [Containers](#) (p. 133).

26.43 Wash Bottle

Use: Washing hands after experiments

Materials: Water bottle, detergent, needle

Procedure: Put a hole in the cap of a water bottle using a syringe needle.

26.44 Water Bath

Use: To heat substances without using a direct flame

Materials: [Heat Source](#), water, cooking pot

Procedure: Bring water to a boil in a small aluminum pot, then place the test tubes in the water to heat the substance inside the test tube. Prevent test tubes from falling over by clamping with clothespins or placing parallel wires across the container.

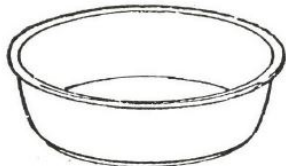
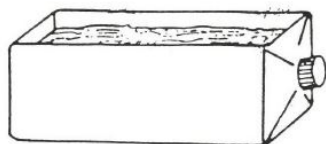

26.45 Weights

26.45.1 Crude Weights

Use: Concept of units, mass, weight

Materials: Batteries, coins, glass marbles from town, etc.

Procedure: Use objects of unknown mass to create new units and impart the concept of unit measure.

26.45.2 Adding Weight in Known Intervals

Use: Hooke’s Law practical

Materials: Water bottles, syringe

Procedure: Consider “zero added mass” the displacement of the pan with an empty water bottle. Then add masses of water in g equal to their volumes in mL (e.g. 50 mL = 50 g).

26.45.3 Precise Weights

Materials: Plastic bags, sand, stones, 250 mL water bottles (all identical), tape, pen

Procedure: Use a beam balance and known masses at a market or nearby school to measure exact masses of bags of sand or stones. Use a marker pen to mark the masses on the bags.

If using water, use a beam balance from a nearby school to measure the exact mass of an empty water bottle. Add a volume of water in mL equal to the mass in g needed to reach a desired total mass. (The density of water is 1.0 g/mL.) This can be done precisely by using a plastic syringe. Label the bottle with tape and a pen.

26.46 White Tiles

Use: Titration

Materials: White paper

Procedure: If students are using syringes as burettes, they can also hold their flask up against a white wall.

26.47 Wire

26.47.1 Connecting Wires

Use: Connecting circuit components, current electricity

Materials: Speaker wire, knife

Procedure: Speaker wire can be found at any hardware store or taken from old appliances - the pairs of colored wires braided together. Strip using a knife, scissors or a wire stripper.



26.48 Wire Gauze

Use: Placing objects over heat

Materials: Tin can lid

Procedure: Poke holes in a tin can lid.

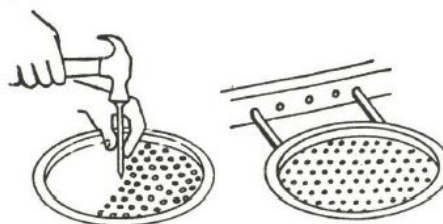

Low Tech Microscopy

Microscopes are powerful tools for teaching biology, and many of their benefits are hard to replace with local fabrications. However, simple materials can be used to achieve sufficient magnification to greatly expand students' understanding of the very small. They may view up close the anatomy of insects and even see cells.

27.1 Water as a lens

Water refracts light much the way glass does; a water drop with perfect curvature can make a powerful lens. A simple magnifier can be made by twisting a piece of wire around a nail and dipping the loop briefly into some water. Students can observe the optical properties of the trapped drop of water.

27.2 Perfect circles

Better imaging can be had if the drop is more perfect in shape – the asymmetry of the wire twisting distorts the image. Search for a piece of thin but stiff plastic – water bottles work well. Cut a small piece of this plastic, perhaps 1 × 2 centimeters. Near one end, make a hole, the more perfect the better. The best hole-cutting tool is a paper hole punch, available in many schools. With care, fine scissors or a pen knife will suffice; remove all burrs.

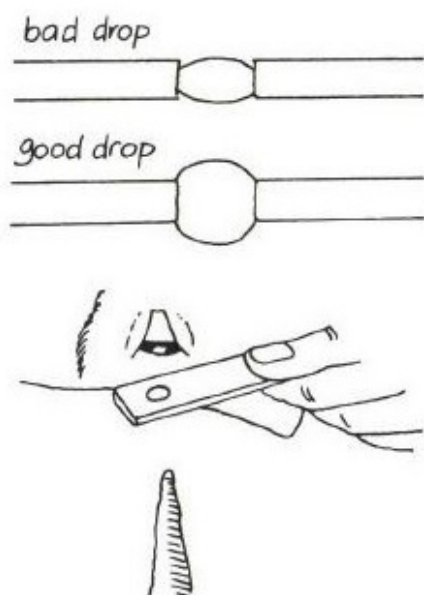

27.3 Slides

A slide and even cover slip may be made from the same plastic water bottles, although being hydrophobic they will not have the same properties of glass when making wet mounts. Improvise a method for securing the punctured plastic over the slide; ideally the vertical spacing can be closely adjusted to focus.

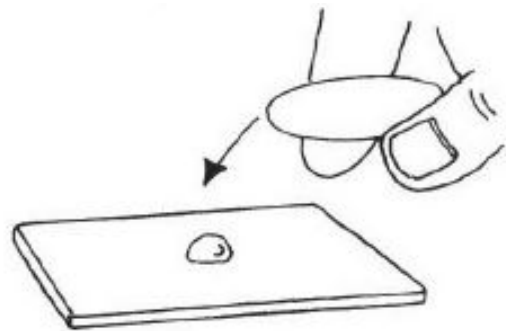

27.4 Backlighting

On a bright day, there may not be any need for additional lighting, but in most classrooms the image will be too dim to be easily seen. The sun is a powerful light source, though not always convenient. Flashlights are generally inexpensive and available; many cell phones have one built in the end. To angle the light into the slide, find either a piece of mirror glass, wrinkle-free aluminum foil, the metalized side of a biscuit wrapper, etc.

Experiment with a variety of designs to see what works best given the materials available to your school. If you use a slide of onion cells stained with iodine solution, your students should be able to see cell walls and nuclei.

27.5 Simple Microscopes and Magnifiers

27.5.1 Clear-Container Magnifiers

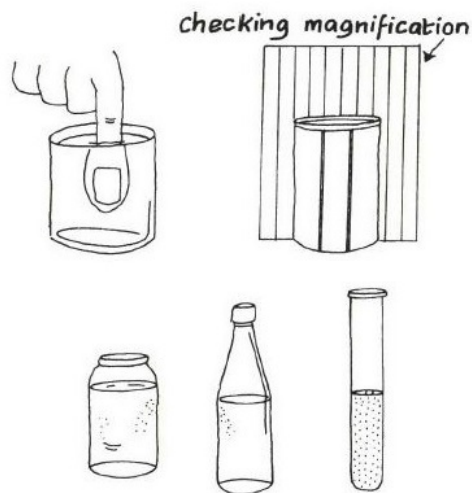

Any of these containers filled with water will make good magnifiers.

27.5.2 Simple Microscope

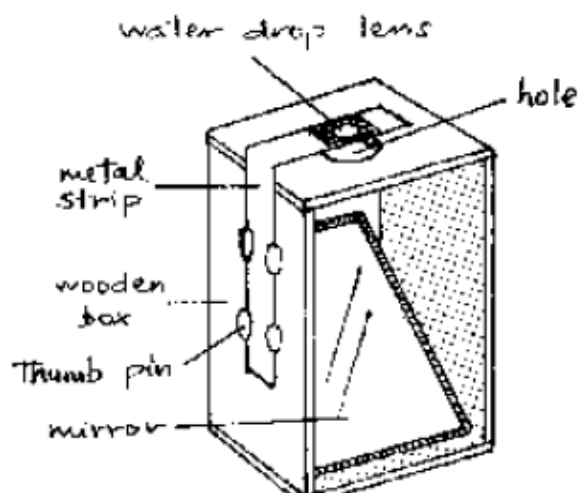

Construct a small wooden box from plywood as shown (or use a small cardboard carton such as a light bulb box). Make a round hole of 2 cm diameter, at the top. Fit a small mirror (glass or polished metal) in the box, angled to reflect light up through the hole. Make a small hole (about 6 mm) in a strip of metal. Remove the round top from a pen-torch bulb and secure it in the strip using adhesive tape. Carefully cut off the tape where it may cover the lens. Bend the strip, then fix it to the side of the box, so that it can be moved up and down. Drawing pins or nails could be used for this. The object is focused by moving this strip. Note

the eye should be placed as near as possible to the lens when viewing.

27.5.3 Simple Compound Microscope

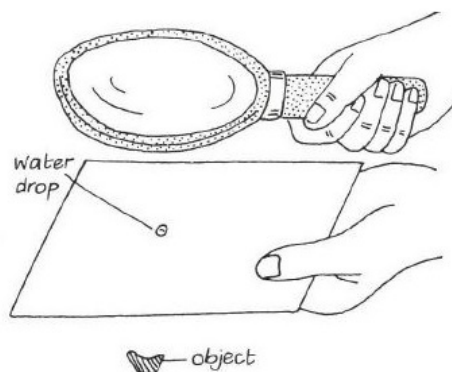

- Using 2 lenses together allows much greater magnification.
- Use a hand lens to make a water drop into a more powerful magnifier.
- Try using a hand lens with a lens from a torch bulb to make another simple compound microscope.

27.5.4 Card Bridge Microscope

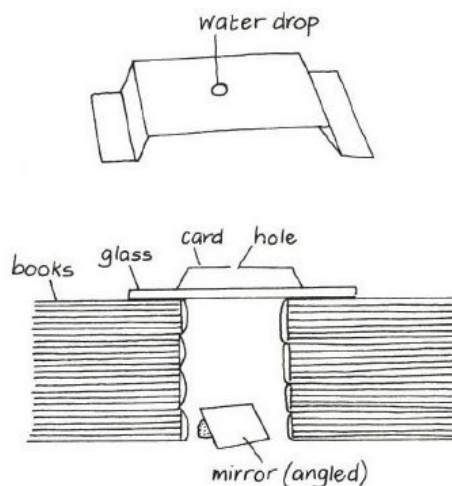

- Place a water drop in the card 'bridge'.
- Place this on a sheet of glass as shown.
- Place the object you are looking at on the glass. This arrangement is most suitable for thin items, e.g. sections of leaves.
- Experiment with the angle of the mirror so that light shines up through the specimen.
- Use this arrangement with a hand lens to produce a compound microscope.

Storage of Materials

28.1 The Science Box

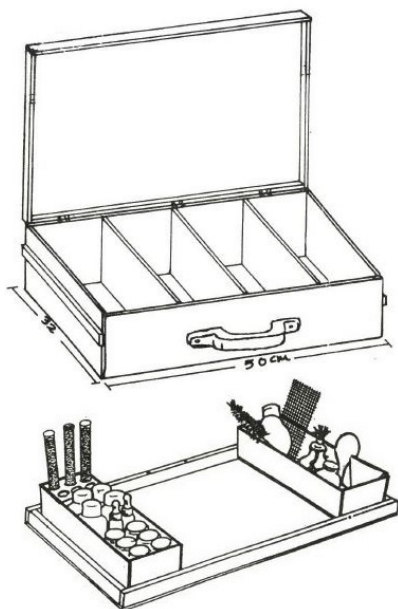

- Use a metal storage trunk to organize all of your new, locally-made science equipment.
- Metal or cardboard sheets can be used as dividers. Tape firmly in place.
- Use the lid as a science tray for safely and easily moving liquids and chemicals.

28.2 Card and Picture Boxes

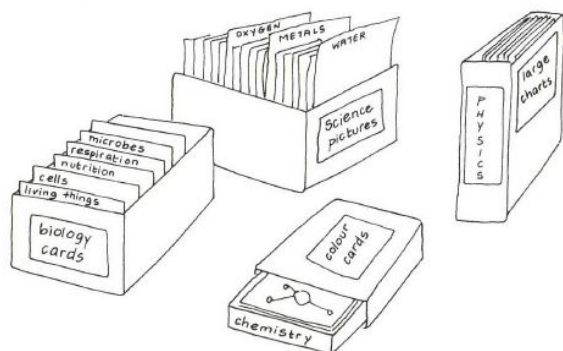

- Cards and pictures can be stored in all sorts of boxes. Store according to syllabus topic or alphabetically.
- Dividers and compartments can be made from cardboard.

28.3 Matchbox Drawers

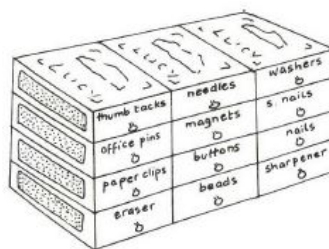

- Drawers to store small items can be made from matchboxes glued together as shown.
- Small pieces of string, wire or buttons can be used as handles.

28.4 Dividing Boxes

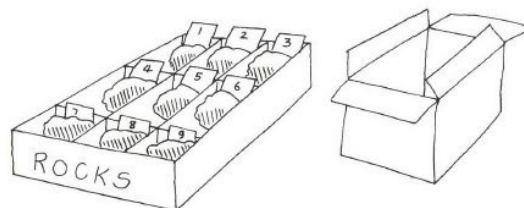

- Cut down the sides of boxes for displays.
- Samples can be sorted, then displayed or stored in cardboard boxes as shown.
- The flaps from the top of the box may be cut off and used as dividers for the same box.

28.5 Envelopes and Bags

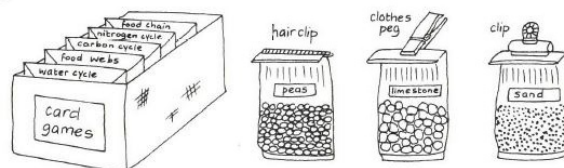

- Envelopes and bags of different sizes can be used for storage. Clearly label all containers.

Pastes and Modeling Materials

29.1 Papier Mâché



- Soak pieces of paper or card in water for half a day.
- Mash, grind, stir or pound the mix to a smooth fine pulp.
- Squeeze or press out excess water.
- Mix in a little flour paste and work the material into a sticky modeling consistency.

29.2 Papier Mâché Layering

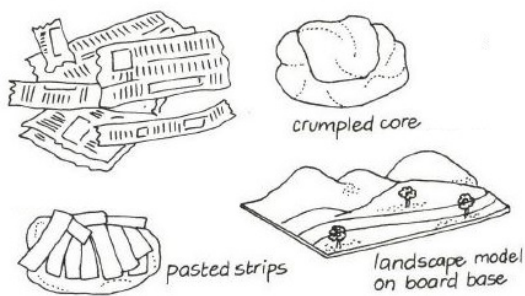

- Soak small pieces, or narrow strips, of newspaper in paste.
- Use crumpled newspaper as a core or skeleton for the model.
- Build up the model in layers of strips and pieces.
- After drying, sandpaper smooth and paint or varnish.

29.3 Modeling Clay



- Dig out or collect your clay. Seek local advice on where to find suitable deposits.
- Add water and stir to a creamy consistency.
- Filter through cloth or a sieve.
- Allow the filtered material to settle.
- Decant excess water.
- Dry the filtered material on newspaper until it becomes a powder.
- Mix in glycerine to give a plastic texture.
- Knead well and add Vaseline to soften if necessary.
- Adding paste (see page 118) to the clay helps stop it cracking as it dries.

29.4 Paste and Sand Cement

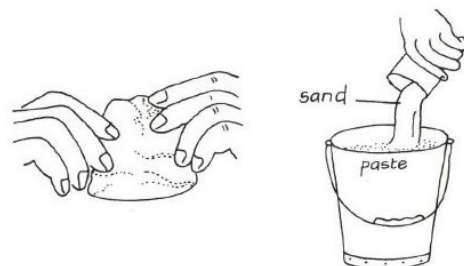

- Mix evenly together dry sand and flour paste or commercial glue.
- The wet cement moulds very easily and dries hard.

29.5 Flour Paste



- Sift flour to remove lumps. Maize, wheat and cassava flours are all suitable.
- Mix the flour with water a little at a time to avoid lumps. It should be the consistency of thin cream.
- Cook the mixture gently until it thickens. Keep stirring to ensure the paste remains smooth and of even texture.
- Allow the paste to cool.
- Add insecticide to the paste if needed.
- Store in a clearly labeled container with a good lid, preferably in a cool place.
- Cold method paste is made by simply stirring sifted flour into water.

29.6 Casein Glue



- Mix milk with vinegar or lemon juice. Add just enough vinegar or lemon juice to curdle the milk. The amounts will vary according to the type of milk used.
- Heat while stirring continuously. Soft lumps will form.
- Strain out the lumps using a cloth.
- Add a teaspoon of sodium hydrogen carbonate (bicarbonate of soda) to the lumps and mix with a little water to produce casein glue.

Sources of Chemicals

The following is a list of most of the chemicals used in science laboratories. Noted for each of the chemicals are local sources, low cost industrial sources, methods to manufacture them at school, and/or functional alternatives. Also listed is information such as other names, common uses and hazards. Finally, descriptions are included of many of the compounds and confirmatory tests to assist with identification of unlabeled chemicals.

Chemicals are generally listed alphabetically by IUPAC name, although many compounds are also cross-listed by their common name (e.g. acetone (common) / propanone (IUPAC)).

30.1 2-methylpropanol

Formula: $(\text{CH}_3)_2\text{CHCH}_2\text{OH}$

Other names: isobutanol

Description: clear liquid less dense than water, alcohol smell similar to isopropanol (American rubbing alcohol)

Use: organic solvent for distribution (partition) experiments

Alternative: paint thinner or kerosene

Note: if ordering this chemical for the national exam, make sure that you get this chemical exactly.

Other compounds, e.g. $\text{CH}_3\text{CH}_2\text{CH}_2(\text{OH})\text{CH}_3$ (butan-2-ol) are sometimes sold as isobutanol but do not work the same way.

30.2 Acetaldehyde

See [Ethanal](#).

30.3 Acetic acid

See [Ethanoic acid](#).

30.4 Acetone

See [Propanone](#).

30.5 Alum

See [Potassium aluminum sulfate](#).

30.6 Ammonia solution

Formula: $\text{NH}_3(\text{aq})$

Other names: ammonium hydroxide, ammonium hydroxide solution

Description: clear liquid less dense than water, completely miscible in water, strong biting smell similar to old urine

Use: qualitative analysis, various experiments

Source: released from an aqueous mixture of ammonium salt and hydroxide, for example calcium ammonium nitrate and sodium hydroxide. The gas can be trapped and dissolved in water.

Alternative: to distinguish between zinc and lead cations, add dilute sulfuric acid dropwise. The formation of a white precipitate – lead sulfate – confirms lead. Note: ammonia solution also is called ammonium hydroxide because ammonia undergoes autoionization to form ammonium and hydroxide ions. Just like water, there is an equilibrium concentration of the ions in an ammonia solution.

30.7 Ammonium dichromate

Formula: $(\text{NH}_3)_2\text{Cr}_2\text{O}_7$

Description: orange crystals soluble in water

Use: qualitative analysis (identification of sulfur dioxide gas)

Hazard: toxic, water pollutant

Alternative: make ammonium/potassium dichromate paper tests. Many can be made from a single gram of ammonium/potassium dichromate.

30.8 Ammonium hydroxide solution

See [Ammonia solution](#).

30.9 Ammonium carbonate, chloride, and nitrate

Use: qualitative analysis, preparation of ammonia
Alternative: to teach the identification and confirmation of ammonium salts and to prepare ammonia, use calcium ammonium nitrate.

30.10 Ammonium sulphate

Formula: $(\text{NH}_4)_2\text{SO}_4$ Other name: sulphate of ammonia
Description: white crystals
Use: qualitative

analysis, preparation of ammonia
Source: fertilizer

30.11 Ammonium thiocyanate

Formula: NH_4SCN

Use: confirmation of iron III in qualitative analysis
Alternative: addition of sodium ethanoate should also produce a blood red solution; additionally, the test is unnecessary, as iron III is also the only chemical that will produce a red/brown precipitate with sodium hydroxide solution or sodium carbonate solution.

30.12 Ascorbic acid

Other names: vitamin C

Formula: $\text{C}_6\text{H}_7\text{O}_7$

Description: white powder, but pharmacy tablets often colored

Confirm: aqueous solution turns blue litmus red AND decolorizes dilute iodine or potassium permanganate solution

Use: all-purpose reducing agent, may substitute for sodium thiosulfate in redox titrations, removes iodine and permanganate stains from clothing

Source: pharmacies

30.13 Barium chloride and barium nitrate

Use: confirmatory test for sulfate in qualitative analysis

Description: white crystals

Hazard: toxic, water pollutant

Alternative: lead nitrate will precipitate lead sulfate – results identical to when using barium

30.14 Boric acid

Formula: H_3BO_3

Description: white powder

Confirm: deep green flame color

Use: flame test demonstrations, preparation of sodium borate

Source: village industry supply shops, industrial chemical

30.15 Benedict's solution

Description: bright blue solution

Confirm: gives orange precipitate when boiled with glucose

Use: food tests (for reducing and non reducing sugars)

Hazard: copper is poisonous

Manufacture: combine 5 spoons of sodium carbonate, 3 spoons of citric acid, and one spoon of copper sulfate in half a liter of water. Shake until everything is fully dissolved.

30.16 Benzene

Formula: C_6H_6

Description: colorless liquid insoluble in water

Use: all purpose organic solvent

Hazard: toxic, highly carcinogenic – see section on Dangerous Chemicals

Alternative: toluene is safer but for most solvent applications kerosene is equally effective and far less expensive.

30.17 Butane

Formula: C_4H_{10}

Source: the fluid in gas lighters is butane under pressure; liquid butane may be obtained at normal pressure with the help of a freezer

30.18 Calcium ammonium nitrate

Other names: CAN

Description: small pellets, often with brown coating; endothermic heat of solvation

Use: low cost ammonium salt for teaching qualitative analysis; not as useful for teaching about nitrates as no red/brown gas released when heated. May be used for the preparation of ammonia and sodium nitrate.

Source: agricultural shops (fertilizer)

30.19 Calcium carbonate

Formula: CaCO_3

Description: white powder, insoluble in water Confirm: brick red flame test and acid causes effervescence

Use: demonstration of reactivity of carbonates, rates of reaction, qualitative analysis

Source: coral rock, sea shells, egg shells, limestone, marble, white residue from boiling water

Local manufacture: prepare a solution of aqueous calcium from either calcium ammonium nitrate or calcium hydroxide and add a solution of sodium carbonate.

Calcium carbonate will precipitate and may be filtered and dried.

30.20 Calcium chloride and calcium nitrate

Description: highly deliquescent colorless crystals (poorly sealed containers often turn into thick liquid)

Use: qualitative analysis salts, drying agents

Alternatives (qualitative analysis): to practice identification of the calcium cation, use calcium sulfate; to practice identification of the chloride anion, use sodium chloride

Alternative (drying agent): sodium sulfate

30.21 Calcium hydroxide

Formula: $\text{Ca}(\text{OH})_2$

Other names: quicklime

Local name: *chokaa*

Description: white to off white powder, sparingly soluble in water

Use: dissolve in carbonate-free water to make lime-water

Source: building supply shops

Alternative: add a small amount of cement to water, let settle, and decant the clear solution; this is limewater.

30.22 Calcium oxide

Formula: CaO

Other names: lime

Use: reacts with water to form calcium hydroxide, thus forming limewater

Source: cement is mostly calcium oxide

30.23 Calcium sulfate

Formula: $\text{CaSO}_4 \cdot 2\text{H}_2\text{O}$

Other names: gypsum, plaster of Paris

Description: white powder, insoluble in cold water but soluble in hot water

Use: qualitative analysis

Source: building supply companies (as gypsum powder)

30.24 Carbon (amorphous)

Source: soot, charcoal (impure)

30.25 Carbon (graphite)

Use: element,

inert electrodes for chemistry and physics Source: dry cell battery electrodes, pencil cores (impure)

30.26 Carbon dioxide

Preparation: react an aqueous weak acid (citric acid or ethanoic acid) with a soluble carbonate (sodium carbonate or sodium hydrogen carbonate)

30.27 Carbon tetrachloride

See [Tetrachloromethane](#).

30.28 Chloroform

See [Trichloromethane](#).

30.29 Citric acid

Formula: $\text{C}_6\text{H}_8\text{O}_7 = \text{CH}_2(\text{COOH})\text{COH}(\text{CHOOH})\text{CH}_2\text{COOH}$

Local name: *unga wa ndimu*

Description: white crystals soluble in water, endothermic heat of solvation

Use: all purpose weak acid, volumetric analysis, melting demonstration, preparation of carbon dioxide, manufacture of Benedict's solution

Hazard: acid keep out of eyes!

Source: markets (sold as a spice), supermarkets

30.30 Cobalt chloride

Use: test for water (hydrated cobalt chloride is pink)

Hazard: cobalt is poisonous

Alternative: white anhydrous copper sulfate turns blue when hydrated

30.31 Copper

Use: element, preparation of copper sulfate, electrochemical reactions

Description: dull red/orange metal

Source: electrical wire – e.g. 2.5 mm gray insulated wire has 50 g of high purity copper per meter.

Note: modern earthing rods are only copper plated, and thus no longer a good source of copper

30.32 Copper carbonate

Formula: CuCO_3

Description: light blue powder

Confirm: blue/green flame test and dilute acid causes effervescence

Use: qualitative analysis, preparation is a demonstration of double decomposition

Hazard: powder may be inhaled; copper is poisonous

Local manufacture: prepare solutions of copper sulfate and sodium carbonate and mix them. Copper carbonate will precipitate and may be purified by filtration and drying.

30.33 Copper chloride and copper nitrate

Description: blue-green (copper chloride) and deep blue (copper nitrate) salts

Use: qualitative analysis

Alternatives: for practice identifying the copper cation, use copper sulfate; for practice identifying the chloride anion, use sodium chloride

30.34 Copper oxygen chloride

Formula: Cu_2OCl

Other names: copper oxychloride, blue copper

Description: light blue powder

Hazard: powder may be inhaled; copper is poisonous

Source: agricultural shops (fungicide)

30.35 Copper sulfate

Formula: CuSO_4 (anhydrous), $\text{CuSO}_4 \cdot 5\text{H}_2\text{O}$ (pentahydrate)

Local name: *mlutulutu*

Description: white (anhydrous) or blue (pentahydrate) crystals

Confirm: blue/green flame test and aqueous solution gives a white precipitate when mixed with lead or barium solution

Use: qualitative analysis, demonstration of the reactivity series, manufacture of Benedict's solution, test for water

Source: imported "local" medicine (manufactured in India).

Local manufacture: Electrolyze dilute (1-2 M) sulfuric acid with a copper anode and inert (e.g. graphite) cathode. Evaporate final solution until blue crystals of copper sulfate pentahydrate precipitate. To prepare anhydrous copper sulfate from copper sulfate pentahydrate, gently heat until the

blue color has faded. Strong heating will irreversibly form black copper oxide. Store anhydrous copper sulfate in an air-tight container – otherwise atmospheric moisture will reform the pentahydrate.

30.36 Dichloromethane

Formula: CH_2Cl_2

Use: organic solvent for distribution (partition) experiments

Hazard: toxic by inhalation and ingestion (mouth pipetting) and by absorption through skin

Alternative: paint thinner or kerosene, although these are less dense than water

30.37 Diethyl ether

Formula: $(\text{CH}_3\text{CH}_2)_2\text{O}$

Description: colorless liquid with smell similar to nail polish remover, evaporates quickly at room temperature

Use: organic solvent for distribution (partition) experiments, demonstration of low boiling point

Hazard: extremely flammable (boils near room temperature) and dangerous to inhale (unfortunate as it is very volatile!). It is of the utmost importance not to mouth pipette this chemical. Breathing ether was the first anesthesia, discontinued because it can be lethal.

Alternatives (distribution/partition): paint thinner or kerosene

Alternative (low boiling point): propanone

30.38 Distilled water

Formula: H_2O and nothing else!

Local name: *maji baridi*

Use: qualitative analysis

Source: rain water.

Allow the first 15 minutes of rain to clean off the roof and then start collecting water. In schools in dry climates, collect as much rain water as possible during the rainy season. Use it only for qualitative analysis, preparation of qualitative analysis reagents, and manufacture of qualitative analysis salts.

Distilled water may also be purchased at most petrol stations and automotive shops.

Local manufacture: Heat water in a kettle and use a rubber hose to bring the steam through a container of cold water. Collect the condensate – pure water.

Alternative: river or tap water is almost always sufficient. Volumetric analysis never needs distilled water if you follow the instructions in Relative Stan-

andardization. Also, the tap water in many places is sufficient for even qualitative analysis.

30.39 Ethanal

Formula: CH_3CHO

Other names: acetaldehyde

Description: clear liquid with a foul smell

Local manufacture: oxidize ethanol with potassium permanganate

Note: the product is truly bad smelling and probably unhealthy to inhale. Include this entry only to show that rather than useful ethanoic acid, one can only get useless ethanal by chemical oxidation of ethanol; manufacture of ethanoic acid requires elevated temperature and high pressure vessels (or biology, as in the traditional manufacture of vinegar). The reaction at small scale (1 mL of ethanol used to decolorize dilute potassium permanganate) is useful when teaching oxidation of alcohols in organic chemistry.

30.40 Ethandioic acid

Formula: $\text{C}_2\text{H}_2\text{O}_4 \cdot 2\text{H}_2\text{O}$

Other names: oxalic acid

Description: clear crystals

Use: volumetric analysis, primary standard for absolute standardization, reducing agent (oxidized to carbon dioxide)

Hazard: poisonous (also acidic)

Alternative: substitute citric acid or ethanoic acid for weak acid solutions and use ascorbic acid as a reducing agent.

30.41 Ethanoic acid

Formula: CH_3COOH

Other names: acetic acid

Description: clear liquid, completely miscible with water, strong vinegar smell

Use: all purpose weak acid, volumetric analysis

Source: 96% solution available from village industry supply shops, vinegar (5% solution) available in small shops and supermarkets

Safety for 96% ethanoic acid: HARMFUL VAPORS. Use outside or in a well ventilated space. CORROSIVE ACID. Always have dilute weak base solution (e.g. sodium hydrogen carbonate) available to neutralize spills. Wear gloves and goggles when handling. Do not induce vomiting if ingested. Alternative: for a weak acid, citric acid.

30.42 Ethanol

Formula: $\text{CH}_3\text{CH}_2\text{OH}$

Description: clear liquid, completely miscible with water, strong and sweet alcohol smell

Use: solvent, extraction of chlorophyll, removes permanent marker, preparation of POP solution, distillation, preservation of biological specimens

Hazard: ethanol itself is a mild poison, and methylated spirits and other industrial alcohol contain additional poisonous impurities (methanol) specifically so that no one drinks it

Sources: methylated spirits are 70% ethanol, hard liquor is often 30-40%, village-brewed concentrated alcohol varies and may contain toxic quantities of methanol

Local manufacture: fermentation of sugar by yeast will produce up to a 15% solution – at that point, the yeast dies; distillation can in theory concentrate this to up to 95%, but this is hard with simple materials. Nevertheless, preparing ethanol of sufficient concentration to dissolve POP (50-60%) is quite possible.

Note: the color of most methylated spirits makes them undesirable for preparation of POP; hard liquor will suffice, but poorly because of its relatively low ethanol content. Colored methylated spirits can be run through a simple distillation apparatus to produce colorless spirits, as the pigment is less volatile than the ethanol. Of course, methanol and other poisons remain, but the clear solution works beautifully for dissolving POP.

Beware that ethanol vapors are flammable – a poorly constructed distillation setup may explode.

30.43 Ethyl acetate

See [Ethyl ethanoate](#).

30.44 Ethyl ethanoate

Formula: $\text{CH}_3\text{COOCH}_2\text{CH}_3$

Other names: ethyl acetate

Description: clear liquid, immiscible with water, smells like nail polish remover

Use: solvent

Source: nail polish remover (mixture with propanone)

Alternative: paint remover, paint thinner, or methylated spirits

Preparation (demonstration of esterification): mix ethanol and ethanoic acid with a catalytic amount of strong acid or base; the decrease in ethanoic acid can be detected by titration and the ethyl ethanoate can be detected by smell.

30.45 Gelatin

Source: may be extracted from chicken bones. This process is lengthy compared to purchasing gelatin powder from supermarkets. Be sure to purchase the non flavored varieties, usually in white boxes.

30.46 Glucose

Formula: $C_6H_{12}O_6$

Description: white powder

Use: food tests (biology), reducing agent

Sources: small shops, pharmacies

Note: for food tests, the vitamins added to most glucose products will not cause a problem

30.47 Gold

Source: a very thin coat of gold is plated onto the electrical contacts of cell phone batteries and mobile phone SIM cards.

30.48 Graphite

See [Carbon \(graphite\)](#).

30.49 Hydrochloric acid

Formula: HCl, 36.5 g/mol, density 1.18 g/cm³ when concentrated (~12 M)

Other names: muriatic acid, pH decreasing compound for swimming pools

Description: clear liquid, may be discolored by contamination, distinct smell similar to chlorine although sometimes smells strongly of vinegar

Confirm: decolorizes weak solutions of potassium permanganate; white precipitate in silver nitrate solution and effervescence with (hydrogen) carbonates

Use: volumetric analysis, qualitative analysis

Source: swimming pool chemical suppliers (impure), industrial chemical (concentrated)

Safety: HARMFUL VAPORS. Use outside or in a well ventilated space. CORROSIVE ACID. Always have dilute weak base solution (e.g. sodium hydrogen carbonate) available to neutralize spills. Wear gloves and goggles when handling. Extremely toxic hydrogen cyanide gas formed on mixing with cyanides or hexacyanoferrate compounds. Toxic chlorine gas formed on reaction with oxidizing agents, especially bleach. Do not induce vomiting if ingested.

Alternative (strong acid): sulfuric acid

Alternative (acid): citric acid

Alternative (qualitative analysis): for the test for

carbonates, use dilute sulfuric acid; to dissolve insoluble carbonates, nitric acid may be used instead

30.50 Hydrogen

Formula: H_2

Confirm: "pop sound," i.e. ignites with a bang; in an inverted test tube the rapid movement of air near the mouth creates a rapid, high pitch "whoosh" that gives the "pop" name

Preparation: combine dilute acid (e.g. battery acid) and a reactive metal (steel wool or zinc) in a plastic water bottle. Attach a balloon to the top of the water bottle; being less dense than air, hydrogen will migrate up and slowly fill the balloon. Specific instructions for various alternatives are available in the Hands-On activities section. Before ignition, always move the balloon away from the container of acid.

30.51 Hydrogen peroxide

Formula: H_2O_2

Local name: *dawa ya vidonda*

Description: solutions are colorless liquids appearing exactly like water

Confirm: decolorizes potassium manganate (VII) solution in the absence of acid, neutral pH

Use: preparation of oxygen, general oxidizer and also may act as a reducing agent (e.g. with potassium permanganate)

Source: pharmacies sell 3% (10 volume) and 6% (20 volume) solutions as medicine for cleaning sores

Note: '20 volume' means it will produce 20 times its liquid volume in oxygen gas.

30.52 Hydrogen sulfide

Formula: H_2S

Description: colorless gas with the smell of rotting eggs, ocean mud, and other places of anaerobic respiration

Safety: the gas is quite poisonous, although the body can detect extremely small amounts

Preparation: a sufficient quantity to smell may be prepared by igniting sulfur in a spoon and then quenching it in water.

30.53 Indicator

Source: red flowers

Preparation: Crush flower petals in water. Some effective flowers include rosella, bougainvillea, and hibiscus. Test other flowers near your school.

Note: For bougainvillea and some other flowers, extract the pigment with ethanol or hard alcohol to get a better color. Color will change from pink (acidic) to colorless (basic). Rosella will change from red (acidic) to green (basic). For an indicator in redox titrations involving iodine, see starch solution.

30.54 Iodine

Formula: $I_{2(s)}$

Description: purple/black crystals

Local manufacture: add a little dilute sulfuric acid to iodine solution from a pharmacy. Then add sodium hypochlorite solution (bleach) dropwise until the solution turns colorless with solid iodine resting on the bottom. The solid iodine can be removed by filtration or decantation. If pure iodine is necessary, the solid may be purified by sublimation.

Note: this reaction produces poisonous chlorine gas. Therefore, produce iodine in a well ventilated area and stand upwind.

30.55 Iodine solution

Composition: $I_2 + KI$ dissolved in water and sometimes ethanol

Description: light brown solution

Confirm: turns starch blue or black

Use: food tests for detection of starch and fats

Source: pharmacies sell a weak iodine solution or tincture of iodine that is really about 50% by mass iodine. To prepare a useful solution for food tests, dilute this 10:1 in ordinary water.

Note: to use this solution for detection of fats, it must be made without ethanol, spirits, alcohol and the like. Either kind works for detection of starch.

30.56 Iron

Use: element, demonstration of reactivity series, preparation of hydrogen, preparation of iron sulfide, preparation of iron sulfate

Source: for samples of the element and for use in electrochemical experiments, buy non-galvanized nails at a hardware store, or find them on the ground. You can tell they are not galvanized because they are starting to rust. Clean off the rust with steel wool prior to use. For samples of the element for preparation of other compounds, buy steel wool from small shops or supermarkets. This has a very high surface area / mass ratio, allowing for faster reactions.

30.57 Iron sulfate

Description: iron (II) sulfate is light green. If exposed to air and especially water, iron (II) sulfate oxidizes to form yellow/red/brown iron (III) sulfate.

Use: oxidation-reduction experiments, qualitative analysis

Local manufacture: add excess steel wool to battery acid and leave overnight or until the acid is completely consumed. Beware! This reaction produces poisonous sulfur dioxide gas! Decant the solution of iron sulfate and leave to evaporate. Gentle heating is useful to speed up evaporation, but be careful to not heat too strongly once crystals form.

Note: the product may contain both iron II sulfate and iron III sulfate – you can guess based on the color. Such a mixture may be used to demonstrate confirmation of iron with potassium hexacyanoferrate (II/III), though not the specificity of one versus the other. To see if any iron II sulfate is present, add a solution of the product to a very dilute solution of potassium permanganate. If the permanganate is decolorized, iron (II) is present. If the solid has any yellow or red color, iron (III) is present.

30.58 Iron sulfide

Use: preparation is a demonstration of chemical changes

Preparation: grind steel wool into a fine powder and mix with a similar quantity of sulfur. This is a mixture that may be physically sorted (e.g. with a magnet). Now, heat the mixture in a spoon over a flame. Iron sulfide will form. This is a chemical compound; the iron and sulfur can no longer be separated by physical means.

30.59 Isobutanol

See [2-methylpropanol](#).

30.60 Lead

Description: soft, dull gray metal

Hazard: toxic, especially its soluble compounds (e.g. lead acetate, chloride, and nitrate) and in powder form (e.g. lead carbonate)

Use: element

Source: electrodes from old car batteries; the old batteries themselves may be purchased from scrap dealers. Remember that the electrolyte may still be 5 M sulfuric acid and thus great care is required when opening these batteries to extract the electrodes. If you pay someone else to extract them,

make sure they understand the hazards and use protective gear (gloves, goggles, etc.).

30.61 Lead nitrate

Formula: $\text{Pb}(\text{NO}_3)_2$

Use: qualitative analysis salt, alternative to barium chloride/nitrate when confirming sulfates

Hazard: toxic, water pollutant

Note: Yes, you could prepare this from lead metal and dilute nitric acid, and yes, this would be less expensive than buying lead nitrate. However, the process of dissolving a reactive metal in a highly corrosive acid to produce a toxic salt is anything but safe. Lead nitrate is a good chemical to purchase. Note that lead does not react with concentrated nitric acid.

30.62 Lead shot

Use: very dense material for building hydrometers, etc.

Source: shotgun shells from a firearm shop – ask them to open them for you

Note: most lead shot these days is actually a bismuth compound to reduce the environmental pollution of spraying lead everywhere. To test the lead shot, put in a ceramic or metal container and heat over a charcoal or kerosene stove. If the metal is lead, it will melt. Bismuth melts at a much higher temperature.

Alternative: If you just need a dense material for physics experiments, use iron and adjust the calibration. This is both safer and less expensive. If you need lead as a chemical reagent 1) see the entry for lead but 2) consider another demonstration with a less poisonous material.

30.63 Lithium ions

Use: flame test demonstrations

Source: broken cell phone batteries from a phone repair shop

Extraction: Open the metal battery case by chipping or smashing it and then prying it open with pliers. There should be sealed packets inside. Stand upwind and cut these open; leave the contents to evaporate the noxious solvent for a few minutes. Do not breathe the fumes. After waiting ten minutes, remove the contents of the packets with pliers and unroll a strip of black covered silvery metal foil. Somewhere in here is some lithium ion. We used to think the silvery metal was lithium. That seems to be incorrect. Regardless, put some of the metal and the black coating into a really hot flame (Bunsen

burner, gas lighter) and you should get the crimson flame color characteristic of lithium.

30.64 Magnesium carbonate

Use: preparation is a demonstration of double displacement reactions as well as a qualitative analysis test

Local manufacture: Mix a solution of magnesium sulfate with a solution of sodium carbonate. Manganese carbonate will precipitate and may be filtered and dried.

30.65 Magnesium sulfate

Formula: $\text{MgSO}_4 \cdot 7\text{H}_2\text{O}$

Other names: epsom salts

Description: white or clear crystals

Use: crystallization experiments, qualitative analysis test reagent (confirmation of hydrogen carbonate and carbonate), precipitation reactions

Source: livestock and veterinary supply shops sell Epsom salts to treat constipation in cattle

30.66 Manganese (IV) oxide

Formula: MnO_2

Other names: manganese dioxide

Description: black powder

Confirm: liberates oxygen from hydrogen peroxide

Use: preparation of oxygen, qualitative analysis (confirmation of chlorides)

Source: old dry cell batteries (radio batteries)

Extraction: smash a dry cell battery with a rock and scrape out the black powder. This is a mixture of manganese dioxide, zinc chloride, and ammonium chloride. This impure mixture is suitable for the preparation of oxygen. To purify manganese dioxide for use in qualitative analysis, boil the powder in water to dissolve away the chlorides. Filter the solution after boiling and repeat if the test gives false positives (e.g. confirms chlorides in samples that lack chlorides)

Note: Wash your hands with soap if you accidentally touch the powder. Do not get it on your clothes or into cuts on your hands. MnO_2 causes metal to corrode; if you use a metal tool to scrap out the powder, be sure to clean it off afterwards. Better: use non-metal tools.

30.67 Methane

Formula: CH_4

Other names: natural gas

Use: optimal Bunsen burner fuel

Local manufacture: biogas systems – a school could in theory build one of these to supply gas for Bunsen burners

Alternative: compressed gas, propane, may be purchased in most towns; this is generally how schools operate Bunsen burners

30.68 Millon's reagent

Composition: mercury metal dissolved in nitric acid

Description: clear liquid, very low pH, addition of excess sodium hydroxide to a small sample produces a yellow precipitate (toxic mercury hydroxide)

Use: identification of proteins in food tests

Hazard: highly toxic and very corrosive – never use
Alternative: sodium hydroxide solution and copper sulfate solution in the Biuret test (1 M NaOH followed by 1% CuSO₄)

30.69 Naphthalene

Formula: C₁₀H₈

Description: solid at room temperature but melts in boiling water, distinct smell of moth balls

Use: melting point and heat of fusion experiments

Source: moth balls are just solid naphthalene

Hazard: poison, possible carcinogen

Alternative: vaseline from small shops is another solid at room temperature that melts in boiling water

30.70 Nestler's reagent

Description: colorless liquid, sometimes with a precipitate at the bottom; addition of excess sodium hydroxide to a small sample produces a yellow precipitate (toxic mercury hydroxide)

Use: detection of ammonia

Hazard: contains dissolved mercury – very toxic
Alternative: ammonia is readily detected by smell; a possible ammonia solution can be confirmed by adding it drop-wise to a solution of copper sulfate – a blue precipitate should form which then dissolves in excess ammonia to form a deep blue / purple solution.

30.71 Nitric acid

Formula: HNO₃

Description: clear liquid though may turn yellow over time, especially if left in the light

Use: various experiments, qualitative analysis, cleaning stubborn residues

Hazard: highly corrosive acid; dissolves essentially everything in the laboratory except glass, ceramics, and many kinds of plastic; may convert organic material into explosives

Alternative (strong acid): battery acid

Alternative (qualitative analysis): have students practice dealing with insoluble carbonates by using copper, iron, or zinc carbonates that will dissolve in dilute sulfuric acid

Alternative (cleaning glassware): make residues in metal spoons that can be cleaned easily by abrasion

30.72 Organic solvents

Sources: kerosene, petrol, paint remover, paint thinner and the safest: cooking oil

30.73 Oxygen

Confirm: oxygen gas relights a glowing splint, i.e. a piece of wood or paper glowing red / orange will flame when put in a container containing much more oxygen than the typical 20% in air

Preparation: combine hydrogen peroxide and manganese (IV) oxide in a plastic water bottle. Immediately crush the bottle to remove all other air and then cap the top. The bottle will re-inflate with oxygen gas.

30.74 Phosphorus

Use: element

Source: the strike pads for matches contain impure red phosphorus

30.75 Potassium aluminum sulfate

Formula: KFe(SO₄)₂

Other names: potassium alum

Local name: *shaabu*

Description: colorless to white crystals, sometimes very large, quite soluble in water

Use: coagulant useful in water treatment – a small amount will precipitate all of the dirt in a bucket of dirty water

Source: various shops, especially those specializing in tradition “Arab” of “Indian” products

30.76 Potassium carbonate

Formula: K₂CO₃

Other names: potash

Description: white powder

Use: volumetric analysis
Safety: rather caustic, keep off of hands and definitely out of eyes!
Alternative: sodium carbonate

30.77 Potassium chromate

Formula: K_2CrO_4
Description: yellow crystals soluble in water
Hazard: poison, water pollutant
Use: demonstration of reversible reactions, qualitative analysis (confirmation of lead)
Alternative (reversible reactions): Dehydrate hydrated copper (II) sulfate by heating and then rehydrate it by adding drops of water
Alternative (confirmation of lead): Confirm lead by the addition of dilute sulfuric acid – white lead sulfate precipitates

30.78 Potassium dichromate

Formula: $K_2Cr_2O_7$
Description: orange crystals soluble in water
Use: demonstration of chemical equilibrium, qualitative analysis (identification of sulfur dioxide gas)
Hazard: toxic, water pollutant
Alternative: make ammonium / potassium dichromate paper tests. Many can be made from a single gram of ammonium/potassium dichromate.

30.79 Potassium hexacyanoferrate (II)

Formula: $K_4Fe(CN)_6$
Other name: potassium ferrocyanide
Description: pale yellow salt
Use: confirmatory tests in qualitative analysis (forms an intensely blue precipitate with iron (III) ions, a red-brown precipitate with copper, and a blue-white precipitate with zinc)
Alternative (confirmation of iron (III) ions): see possibilities listed with ammonium thiocyanate
Alternative (confirmation of copper): blue/green flame test, blue precipitate on addition of sodium hydroxide or sodium carbonate solution

30.80 Potassium hexacyanoferrate (III)

Formula: $K_3Fe(CN)_6$
Other name: Potassium ferricyanide
Description: yellow / orange salt
Use: confirmatory tests in qualitative analysis (makes an intense blue precipitate in the presence

of iron (II) ions
Alternative: iron (II) ions will also instantly decolorize a weak, acidic solution of potassium manganate (VII)

30.81 Potassium hydroxide

Formula: KOH
Description: white crystals, deliquescent (poorly sealed containers may be just viscous water)
Use: volumetric analysis
Hazard: corrodes metal, burns skin, and can blind if it gets in eyes
Alternative: sodium hydroxide

30.82 Potassium iodide

Formula: KI
Description: white crystals very similar in appearance to common salt, endothermic heat of solvation
Confirm: addition of weak potassium permanganate or bleach solution causes a clear KI solution to turn yellow/brown due to the formation of I_2 (which then reacts with I^- to form soluble I_3^-)
Use: preparation of iodine solution for food tests in biology, preparation of iodine solutions for redox titrations, confirmatory test for lead in qualitative analysis
Local manufacture: Heat a pharmacy iodine tincture strongly until only clear crystals remain. In this process, the I_2 will sublime – placing a cold dish above the iodine solution should cause most of the iodine to deposit as solid purple crystals. Note that the iodine vapors are harmful to inhale. If you need KI for a solution that may contain impurities, add ascorbic acid solution to dilute iodine tincture until the solution exactly decolorized.
Alternative (food tests): see [Iodine solution](#)
Alternative (redox titrations): often you can also use iodine solution for this; just calibrate the dilution of pharmacy tincture and the other reagents to create a useful titration
Alternative (qualitative analysis): confirm lead by the addition of dilute sulfuric acid – white lead sulfate precipitates

30.83 Potassium manganate (VII)

Formula: $KMnO_4$
Other names: potassium permanganate, permanganate
Description: purple/black crystals, sometimes with a yellow/brown glint, very soluble in water – a few crystals will create a strongly purple colored solution

Hazard: powerful oxidizing agent – may react violently with various compounds; solutions stain clothing (remove stains with ascorbic acid solution); crystals and concentrated solution discolor skin (the effect subsides after a few hours, but it is better to not touch the chemical!)

Use: strong oxidizer, self-indicating redox titrations, identification of various unknown compounds, diffusion experiments

Source: imported “local” medicine. Also sold in very small quantities in many pharmacies. May be available in larger quantities from hospitals.

Alternative (oxidizer): bleach (sodium hypochlorite), hydrogen peroxide

Alternative (diffusion experiments): solid or liquid food coloring, available in markets and small shops

30.84 Potassium thiocyanate

Formula: KSCN

Use: confirmation of iron (III) ions in qualitative analysis

Alternative: addition of sodium ethanoate should also produce a blood red solution; additionally, the test is unnecessary, as iron (III) ions is also the only chemical that will produce a red/brown precipitate with sodium hydroxide solution or sodium carbonate solution

30.85 Propanone

Formula: H_3CCOCH_3

Other names: acetone

Description: clear liquid miscible in water, smells like nail polish remover, quickly evaporates

Use: all-purpose lab solvent, iodoform reaction (kinetics, organic chemistry)

Hazard: highly flammable

Source: nail polish remover (mixture with ethyl ethanoate)

Alternative (volatile polar solvent): ethanol, including methylated spirits

30.86 Silicon

Use: element

Source: fragments of broken solar panels; the cells are in part doped silicon

30.87 Silicon dioxide

Description: clear solid

Source: quartz rock, quartz sand, glass

30.88 Silver nitrate

Formula: AgNO_3

Description: white crystals, turn black if exposed to light (hence, the use of silver halides in photography)

Confirm: silvery-white precipitate formed with chlorides

Use: confirmatory test for chlorides in qualitative analysis

Hazard: poison, water pollutant

Alternative: heat sample together with a dilute solution of acidified potassium manganate (VII) – decolorization confirms chlorides

30.89 Sodium

Description: very soft metal (cuts with a knife) with a silvery color usually obscured by a dull oxide; always stored under oil

Use: demonstration of reactive metals (add to water)

Hazard: reacts with air and violently with water. May cause fire.

30.90 Sodium acetate

See [Sodium ethanoate](#).

30.91 Sodium carbonate

Formula: $\text{Na}_2\text{CO}_3 \cdot 10\text{H}_2\text{O}$ (hydrated), Na_2CO_3 (anhydrous)

Other names: soda ash, washing soda

Description: white powder completely soluble in water

Use: all-purpose cheap base, volumetric analysis, qualitative analysis, manufacture of other carbonates

Safety: rather caustic, keep off of hands and definitely out of eyes!

Source: commercial and industrial chemical supply – should be very inexpensive

Local manufacture: dissolve sodium hydrogen carbonate in distilled water and boil for five or ten minutes to convert the hydrogen carbonate to carbonate. Let evaporate until crystals form. For volumetric analysis, the hydrated salt may always substitute for the anhydrous with a correction to the concentration – see Chemical Substitutions for Volumetric Analysis

30.92 Sodium chloride

Formula: NaCl

Other names: common salt

Use: all-purpose cheap salt, qualitative analysis

Source: the highest quality salt in markets (white, finely powdered) is best. The iodine salts added to prevent goiter do not generally affect experimental results.

30.93 Sodium citrate

Use: buffer solutions, preparation of Benedict's solution

Local manufacture: react sodium hydroxide and citric acid in a 3:1 ratio by mole

Alternative: to prepare Benedict's solution, see [Benedict's solution](#).

30.94 Sodium ethanoate

Formula: CH₃COONa

Other names: sodium acetate

Use: confirmation of iron (III) ions

Local manufacture: react sodium hydrogen carbonate and ethanoic acid in a 1:1 ratio by mole – one 70 g box of baking soda to one liter of white vinegar labelled 5%; if you need to err add excess sodium hydrogen carbonate. If the solid is required, leave to evaporate, but mostly likely you want the solution.

30.95 Sodium hydrogen carbonate

Formula: NaHCO₃

Description: white powder, in theory completely soluble in cold water in practice often dissolves poorly

Other names: sodium bicarbonate, bicarbonate of soda

Use: all-purpose weak base, preparation of carbon dioxide, qualitative analysis

Source: small shops

Note: may contain ammonium hydrogen carbonate

30.96 Sodium hydroxide

Formula: NaOH

Other names: caustic soda

Description: white deliquescent crystals – will look wet after a minute in contact with air and will fully dissolve after some time, depending on humidity and particle size

Use: all-purpose strong base, volumetric analysis,

food tests in biology, qualitative analysis, preparation of sodium salts of weak acids

Hazard: corrodes metal, burns skin, and can blind if it gets in eyes

Source: industrial supply shops, supermarkets, hardware stores (drain cleaner)

Local manufacture: mix wood ashes in water, let settle, and decant; the resulting solution is mixed sodium and potassium hydroxides and carbonates and will work for practicing volumetric analysis

Note: ash extracts are about 0.1 M base and may be concentrated by boiling; this is dangerous, however, and industrial caustic soda is so inexpensive and so pure that there is little reason to use ash extract other than to show that ashes are alkaline and that sodium hydroxide is not exotic.

30.97 Sodium hypochlorite solution

Formula: NaOCl_(aq)

Other names: bleach

Local name: Jik Use: oxidizing agent

Source: small shops, supermarkets

Local manufacture: electrolysis of concentrated salt water solution with inert (e.g. graphite) electrodes; 4-5 V (three regular batteries) is best for maximum yield

Note: commercial bleach is usually 3.5% sodium hypochlorite by weight

30.98 Sodium nitrate

Formula: NaNO₃

Description: colorless crystals

Use: qualitative analysis

Hazard: oxidizer, used in the manufacture of explosives e.g. gunpowder

Alternative: to practice identification of the sodium cation, use sodium chloride

Local manufacture: Mix solutions of calcium ammonium nitrate and sodium carbonate and decant the clear solution once the precipitate (calcium carbonate) settles. Add a stoichiometric quantity of sodium hydroxide and let the reaction happen either outside or with under a condenser to trap the ammonia produced. The clear solution that remains should have no residual ammonia smell and should be neutral pH. Allow the solution to evaporate until sodium nitrate crystallizes.

30.99 Sodium oxalate

Formula: Na₂C₂O₄

Use: demonstration of buffer solutions

Hazard: poisonous

Alternative: rather than oxalic acid / sodium oxalate, use citric acid / sodium citrate

30.100 Sodium sulfate

Formula: Na_2SO_4

Use: qualitative analysis

Local manufacture: combine precisely stoichiometric amounts of copper sulfate and sodium carbonate in distilled water. A balance is required to measure exactly the right amounts. Copper carbonate will precipitate and the resulting solution should contain only sodium sulfate. Filter out the copper carbonate and evaporate the clear solution to dryness. Sodium sulfate is thermally stable, so strong heating may be used to speed up evaporation.

30.101 Sodium thiosulfate

Formula: $\text{Na}_2\text{S}_2\text{O}_3 \cdot 5\text{H}_2\text{O}$

Description: clear, hexagonal crystals

Use: reducing agent for redox titrations, sulfur precipitation kinetics experiments

Alternative (reducing agent): ascorbic acid

Alternative (kinetics): reaction between sodium hydrogen carbonate solution and dilute weak acid (citric acid or ethanoic acid), iodoform reaction (iodine solution and propanone)

30.102 Succinic acid

Formula: $\text{HOOCCH}_2\text{CH}_2\text{COOH}$

Description: white solid

Use: solute for partitioning in distribution (partition) experiments

Alternative: iodine also partitions well between aqueous and organic solvents; titrate iodine with ascorbic acid (or sodium thiosulfate) rather than sodium hydroxide as you would with succinic acid; ethanoic acid also partitions between some solvent combinations.

30.103 Sucrose

Formula: $\text{C}_{12}\text{H}_{22}\text{O}_{11}$

Use: non-reducing sugar for food tests

Source: common sugar; the brown granular sugar at the market and in small shops is more common; the more refined white sugar is available in supermarkets

Note: sometimes impure sucrose causes Benedict's solution to turn green, even yellow. Try using more refined sugar. Alternatively, insist to students that only a red/orange precipitate is a positive test for a reducing sugar during exams.

30.104 Sudan III solution

Use: testing for fats in food tests

Alternative: ethanol-free iodine solution

30.105 Sulfur

Local name: *kibiriti upele*

Description: light yellow powder with distinct sulfurous smell

Use: element, preparation of iron sulfide

Source: large agricultural shops (fungicide, e.g. for dusting crops), imported "local" medicine

30.106 Sulfuric acid

Formula: H_2SO_4

Other names: battery acid

Local name: *maji makali*

Description: clear liquid with increasing viscosity at higher concentrations; fully concentrated sulfuric acid (~18 M) is almost twice as dense as water and may take on a yellow, brown, or even black color from contamination

Use: all-purpose strong acid, volumetric analysis, qualitative analysis, preparation of hydrogen and various salts

Source: battery acid from petrol stations is about 4.5 M sulfuric acid and one of the least expensive sources of acid

Hazard: battery acid is dangerous; it will blind if it gets in eyes and will put holes in clothing. Fully concentrated sulfuric acid is monstrous, but fortunately never required. For qualitative analysis, "concentrated" sulfuric acid means ~5 M – battery acid will suffice.

Note: "dilute" sulfuric acid should be about 1 M. To prepare this from battery acid, add one volume of battery acid to four volumes of water (e.g. 100 mL battery acid + 400 mL water)

30.107 Starch

Description: light weight, fine, white powder, not readily soluble in cold water

Confirm: makes a blue to black color with iodine solution

Use: preparation of starch solution

Source: supermarkets

30.108 Starch solution

Use: sample for food tests, indicator for redox titrations involving iodine

Source: dilute the water left from boiling pasta or

potatoes

Note: prepare freshly – after a day or two it will start to rot!

30.109 Tetrachloromethane

Formula: CCl_4

Other names: carbon tetrachloride

Description: clean liquid, insoluble in and more dense than water

Use: organic solvent for distribution (partition) experiments

Hazard: toxic, probably carcinogen – never use

Alternative: other organic solvents – paint thinner and kerosene are the least expensive

30.110 Trichloromethane

Formula: CHCl_3

Other names: chloroform

Description: clear liquid, insoluble in and more dense than water, noxious smell

Use: rendering biological specimens unconscious prior to dissection, as an organic solvent for the distribution (partition) experiments

Alternative (biology): the specimen will die regardless so unless you are investigating the circulatory system you might as well kill it in advance; this also avoids the problem of specimens regaining consciousness before they bleed to death. See instructions in Dissections.

Alternative (chemistry): lower cost and safer organic solvents like kerosene can be used to practice distribution (partitioning), but unlike chloroform they are less dense than water.

30.111 Tungsten

Symbol: W

Use: element

Source: incandescent light bulb filaments

Extraction: wrap a light bulb in a rag and break it with a blunt object. The filament is the thin coiled wire. Dispose of the broken glass in a safe place, like a pit latrine.

Note: in a dead bulb, the cause of failure is probably the filament, so there might not be much left.

30.112 Zinc

Description: firm silvery metal, usually coated with a dull oxide

Use: element, preparation of hydrogen, preparation of zinc carbonate and zinc sulfate

Source: dry cell batteries; under the outer steel shell is an inner cylinder of zinc. In new batteries, this whole shell may be extracted. In used batteries, the battery has consumed most of the zinc during the reaction, but there is generally an unused ring of zinc around the top that easily breaks off. Note that alkaline batteries, unlike dry cells, are unsafe to open – and much more difficult besides.

30.113 Zinc carbonate

Formula: ZnCO_3

Description: white powder

Use: qualitative analysis

Local manufacture: dissolve excess zinc metal in dilute sulfuric acid and leave overnight or until the acid is completely consumed. Decant the resulting zinc sulfate solution and mix with a sodium carbonate solution. Zinc carbonate will precipitate and may be purified by filtration and gentle drying.

30.114 Zinc chloride and zinc nitrate

Description: clear, deliquescent crystals

Use: qualitative analysis

Alternative: to practice identification of zinc, use zinc sulfate or zinc carbonate; to practice identification of chloride use sodium chloride

30.115 Zinc sulfate

Formula: ZnSO_4

Use: qualitative analysis

Local manufacture: dissolve excess zinc metal in dilute sulfuric acid and leave overnight or until the acid is completely consumed. Decant the resulting zinc sulfate solution and evaporate until crystals form.

Common Chemistry Root Words

Table A.1 – Root Words Used Frequently in Chemistry

Root	Meaning	Example	Explanation
<i>-ane</i>	single covalent bond	alkane, propane	alkanes have only single bonds
<i>-ene</i>	double covalent bond	alkene, polypropylene	alkenes have one or more double bonds
<i>-oid</i>	like, form	metalloid	some properties are like those of metals
<i>-yne</i>	triple covalent bond	alkyne, ethyne	alkynes have one or more triple bonds
<i>-meter</i>	measure	calorimeter	measures heat of reactions
<i>a-</i>	not, without	amorphous carbon	carbon without crystalline shape
<i>anti</i>	against, opposite	antiseptic	substance that works against microbes
<i>bi</i>	two	binary compounds	compound made of two elements
<i>carb, -o, -on</i>	coal, carbon	carbohydrate	compound made of carbon, hydrogen and oxygen $(CH_2O)_n$
<i>co, -l, m, -n</i>	with, together	coefficient, colligative	number that appears with a formula in a chemical equation
<i>com</i>	with, together	composition reaction	a reaction in which molecules are assembled
<i>de</i>	down, without, from	decomposition, denature, dehydrate	a reaction in which materials are broken down
<i>di</i>	separate, double, across	disaccharide	two monosaccharides tied together
<i>dis</i>	separate, apart	dissociation	separation of ions when dissolving
<i>ef</i>	out, from, away	effervescence	rapid escape of gas from a liquid in which it is dissolved
<i>en</i>	in, into	endothermic	a reaction which takes in heat
<i>hetero-</i>	other, different	heterogeneous mixture	a mixture in which properties and composition differ from point to point
<i>hom, eo, -o</i>	same, alike	homogenous mixture	a mixture in which properties and composition are the same throughout
<i>hyper</i>	over, above, excessive	(<i>hy</i>)perchloric acid	the oxidation state of chlorine in perchloric acid is above what it is in chloric acid
<i>hypo</i>	under, beneath	hypochlorous acid	the oxidation state of chlorine in hypochlorous acid is below the oxidation state of chlorine in chlorous acid
<i>im</i>	not	immiscible	not mutually soluble (not miscible)
<i>iso</i>	equal	isomers	compounds that have the same molecular formula, but different structures
<i>lys, -io, -is</i>	loose, loosening, breaking	hydrolysis	the breaking apart of a substance by an electric current
<i>macr, -o</i>	large, long	macromolecule	macromolecules are large organic molecules
<i>mon -a, -er, -o</i>	single, one	monomer	single molecular units that can join to form a polymer

Continued on next page

Table A.1 – continued from previous page

Root	Meaning	Example	Explanation
<i>morph, -a, -o</i>	form	amorphous sulfur	sulfur without definite crystals or shape
<i>nom, -en, -in</i>	name	nomenclature	system of assigning names
<i>nuc, -ell, -i</i>	nut, center	nucleus	center of the atom
<i>oct, -i, -o</i>	eight	octet rule	tendency to acquire a total of 8 electrons in highest energy level
<i>photo</i>	light	photochemical smog	air pollutants transformed by sunlight
<i>poly</i>	many	polymer	many molecules bound together to make a new, longer molecule
<i>syn</i>	together, with	photosynthesis	molecules are put together with energy derived from light
<i>therm, -o</i>	heat	thermochemistry	the study of changes in heat energy accompanying chemical and physical changes
<i>thesis</i>	an arranging, statement	hypothesis	a testable statement
<i>tran, -s</i>	across, through	transition elements	elements through which you pass when going from the right to left side of the periodic table
<i>un</i>	not	unsaturated	bonds that are not saturated

Activity Template

The Shika members know that there is always room for new and improved activities, and it is much appreciated, so below is a template for contributing activities to the current manuals.

Please fill out the table below and send it to **shika.mikono.tz@gmail.com**. Not every cell has to be filled in - some cells may not be applicable to each activity. Examples of how the activities should look can be found throughout this manual. Corresponding pictures can also be sent to the above email address.

Section	Fill this in...	Comments
Title		The title of your activity
Form, Topic, and Subtopic		The form, topic, and subtopic that this activity applies to in the syllabus
Materials		List all the materials needed to complete the activity
Setup		What to do to prepare the activity
Procedure		How to carry out the actual activity
Hazards		If there is any danger involved with the activity, state it here and what to do if it happens
Questions		Possible follow-up or discussion questions
Observations		State what is observed as a result of the activity
Theory		Background information and theory behind the activity
Applications		Any real-life applications or uses of the activity
Notes		Any other information that should be stated about the activity